

# Life in your bathroom



BATHROOM ACCESSORIES  
BADRUMSTILLBEHÖR  
BADEVÆRELSESTILBEHØR  
BADEROMSTILBEHØR  
KYLPUHUONETARVIKKEET  
BAD ACCESSOIRES

 **SMEDBO**

# Life in your bathroom

- EN If you're looking to renew your bathroom with timeless bathroom accessories, searching for a practical and stylish bathroom detail or just browsing for inspiration, we welcome you to our stylish world of bathroom accessories.
- SE Om du vill förnya ditt badrum med badrumsserier i tidlös design, letar efter en praktisk och snygg badrumsdetalj eller bara söker inspiration, hälsar vi dig varmt välkommen till vår stilfulla värld av badrumstillbehör!
- DK Hvis du vil forny dit badeværelse med en tidløs badeværelseserie, leder efter en praktisk og stilfuld detalje til badeværelset, eller bare leder efter inspiration, byder vi dig varmt velkommen til vores stilfulde verden af badeværelsestillbehør!
- NO Om du ønsker å fornye badet med baderomsserier i tidløs design, leter etter en praktisk og pen baderomsdetalj eller bare søker inspirasjon, ønsker vi deg hjertelig velkommen til vår stilfulle verden av baderomstillbehør.
- FI Jos suunnittelet kylpyhuoneesi päivittämistä ajattomilla tarvikkeilla, etsit tyylikkäitä ja käytännöllisiä yksityiskohtia tai olet vain etsimässä inspiraatiota, toivotamme sinut tervetulleeksi ensiluokkaisten kylpyhuonetarvikkeiden maailmaan.
- DE Wenn Sie Ihr Bad mit zeitlosen Bad-Accessoires erneuern möchten, auf der Suche nach einem praktischen und stilvollen Badezimmerdetail oder einfach nur nach Inspiration sind, begrüßen wir Sie in unserer stylischen Welt der Bad-Accessoires.



Product lines



**AIR** 12-17  
Bathroom accessories



**DRY** 18-25  
Heated towel rails



**HOME** 26-35  
Bathroom accessories



**HOUSE** 36-47  
Bathroom accessories



**ICE** 48-53  
Bathroom accessories



**LIVING** 54-59  
Care & safety



**OUTLINE** 60-69  
Mirrors & accessories



**OUTLINE LITE** 70-77  
Freestanding products



**POOL** 78-83  
Bathroom accessories



**SIDELINE** 84-95  
Shower baskets



**VILLA** 96-99  
Bathroom accessories



**XTRA** 99-104  
Spare parts



**iGLUE** 105  
Drill-free mounting



**INFO** 107  
Materials and warranty

## With a sense of tradition



### EN **With a sense of tradition**

For over 50 years we at Smedbo have been designing and distributing high quality bathroom accessories. Ever since 1967 and the launch of the Herrgård series, our goal has been to give the bathroom a sense of flair and elegance. Today, with several loved bathroom ranges in our portfolio, we are happy to see that the bathroom is no longer thought of as "the forgotten room" as it was in the 60's. Now, the bathroom is a place for fantastic design and personal expression.

### SE **Med känsla för tradition**

I över 50 år har vi på Smedbo designat och sålt badrumstillbehör av hög kvalitet. Ända sedan 1967 och lanseringen av serien Herrgård har vårt mål varit att ge badrummet en känsla av flärd och elegans. Idag, med en rad uppskattade badrumsserier i bagaget, kan vi glatt konstatera att badrummet inte längre ses som "det glömda rummet" som på 60-talet. Nu tar badrummet plats som ett rum med fantastiska möjligheter till design och personligt uttryck.

### DK **Med en følelse af tradition**

I over 50 år har vi hos Smedbo designet og solgt badeværelsestilhør i høj kvalitet. Lige siden 1967 og lanceringen af Herrgård-serien har vores mål været at give badeværelset en følelse af flair og elegance. I dag, med en række værdsatte badeværelsesserier i bagagen, kan vi med glæde oplyse, at badeværelset ikke længere ses som "det glemte rum" som i 60'erne. Nu er badeværelset istedet et rum med fantastiske muligheder for design og personlig udtryk.

# 1967

- The Herrgård series was launched in 1967
- Serien Herrgård lanserades 1967
- Herrgård-serien blev lanceret i 1967
- Herrgård-serien ble lansert i 1967
- Herrgård-sarja lanseerattiin vuonna 1967
- Die Herrgård-Serie wurde 1967 auf den Markt gebracht

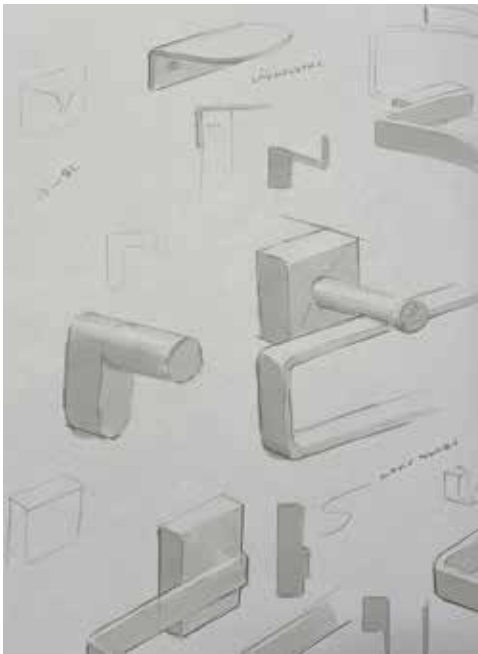

## NO **Med følelse av tradisjon**

I over 50 år har vi i Smedbo designet og solgt baderomstilbehør av høy kvalitet. Helt siden 1967 og lanseringen av serien Herregård har målet vårt vært å gi badet en følelse av stil og eleganse. I dag med en rekke populære baderoms-serier i bagasjen, kan vi konstantere at badet ikke lengre sees på som "det glemte rommet», slik det var på 60-tallet. Nå er badet et rom med utrolige muligheter for design og personlige uttrykk.

## FI **Perinteitä kunnoittaen**

Olemme Smedbolla suunnitelleet ja toimittaneet laadukkaita kylpyhuonetarvikkeita jo yli 50 vuoden ajan. Aina vuodesta 1967 julkaistun Herrgård sarjan jälkeen, on tavoitteemme ollut tarjota kylpyhuoneeseen elegantteja ja silmiinpistäviä tuotteita. Nykyään, useiden kiitelyjen tarvikesarjojen jälkeen voimme iloksemme todeta, että kylpyhuonetta ei enää ajatella "unohdettuna huoneena" kuten aikaisemmin. Tänä päivänä kylpyhuone on mitä parhain paikka designiin ja oman tyyli-suunnan esiintuomiseen.

## DE **Mit einem Sinn für Tradition.**

Seit über 50 Jahren gestalten und vertreiben wir bei Smedbo hochwertige Bad-Accessoires. Seit 1967 und der Einführung der Herrgård-Serie ist es unser Ziel, dem Bad ein Gefühl von Flair und Eleganz zu verleihen: Heute, mit mehreren beliebten Badserien in unserem Portfolio, freuen wir uns zu sehen, dass das Bad nicht mehr als der vergessene Raum betrachtet wird, wie es in den 60er Jahren der Fall war. Nun ist das Badezimmer ein Ort für fantastisches Design und individuellen Ausdruck."

# Design and function

## EN **Design and function**

Certainly, beautiful things are amazing to look at. At Smedbo, we have for decades developed products with a strong classic, Scandinavian design. However, we never settle for a product being only beautiful or elegant. In addition, it must have a strong function and meet the needs of the user.

A product that is both beautiful and functional will definitely deserve its place in the bathroom.

## SE **Design och funktion**

Visst är vackra saker fantastiska att se på. På Smedbo har vi under årtionden utvecklat produkter med en formstark klassisk, skandinavisk design.

Vi stannar dock aldrig vid att en produkt ska vara vacker eller elegant. Den måste dessutom ha en stark funktion och tillgodose användarens behov.

En produkt som är både vacker och funktionell kommer definitivt att förtjäna sin plats i badrummet.

## DK **Design og funktion**

Når disse to begreb går hånd i hånd så bliver det fantastiske at se på. Hos Smedbo har vi i årtier udviklet produkter i et stærkt klassisk, skandinavisk design. Derudover skal det have en stærk funktion og imødekomme brugerens behov.

Et produkt, der er både smukt og funktionelt, fortjener bestemt sin plads i badeværelset.

## NO **Design og funksjon**

Visst er vakre ting fantastisk å se på. På Smedbo har vi i årtier utviklet produkter med et formsterkt klassisk skandinavisk design. Vi er derimot ikke fornøyde med at produktet kun er vakkert og elegant. Det må i tillegg ha en funksjon og imøtekomme brukerens behov.

Et produkt som er både vakkert og funksjonelt vil definitivt finne sin fortjente plass på baderommet.

## FI **Design ja toiminnallisuus**

Tiedostamme, että kauniiden asioiden katselu on mukavaa. Olemme jo vuosikymmeniä Smedbolla kehittäneet vahvasti klassisia tuotteita Skandinaavisella designilla. Emme kuitenkaan ikinä tyydy siihen, että tuote on pelkästään kaunis tai elegantti. Tämän lisäksi tuotteella tulee olla selkeä käyttötarkoitus ja sen tulee tyydyttää käyttäjän tarpeet.

Tuote joka on sekä kaunis, että toiminnallinen ansaitsee ehdottomasti paikkansa kylpyhuoneessa.

## DE **Design und Funktionalität**

Sicher, schöne Dinge sind faszinierend anzusehen. Bei Smedbo entwickeln wir seit Jahrzehnten Produkte mit einem starken klassischen, skandinavischen Design. Wir geben uns jedoch nie damit zufrieden, dass ein Produkt nur schön oder elegant ist. Darüber hinaus muss es eine starke Funktionalität haben und den Bedürfnissen des Anwenders entsprechen.

Ein Produkt, das sowohl ästhetisch wie auch funktionell ist, wird definitiv seinen Platz im Badezimmer einnehmen.





## Focus on quality



### EN **Focus on quality**

Long service life and high quality are two of the most important building blocks in designing and developing products. The majority of our bathroom series are made of solid brass and then surface treated for a certain finish. The surface treatment makes the products even more resistant and increases their durability. This focus on high quality allows our products to be used regularly over a long period of time, therefore we are confident in offering guarantees of 5 to 10 years on all our products.

### SE **Fokus på kvalitet**

Lång livslängd och hög kvalitet är två av de viktigaste byggstenarna när vi designar och utvecklar produkter. Majoriteten av våra badrumsserier är tillverkade i massiv mässing som sedan ytbehandlas. Ytbehandlingen gör produkterna än mer motståndskraftiga och ökar deras hållbarhet. Den höga kvalitén innebär att produkterna kan användas längre och det känns självklart för oss att därmed lämna 10, alternativt 5, års garanti på alla våra produkter.

### DK **Fokus på kvalitet**

Lang levetid og høj kvalitet er to af de vigtigste byggesten til design og udvikling af produkter. Størstedelen af vores badeværelsesserier er lavet af massiv messing og derefter overfladebehandlet. Overfladebehandlingen gør produkterne endnu mere modstandsdygtigt og øge deres holdbarhed. Den høje kvalitet betyder, at produkterne kan bruges længe, og det føles naturligt for os at give 10 eller 5 års garanti på alle vores produkter.





NO

### Fokus på kvalitet

Lang levetid og høy kvalitet er grunnleggende når vi designer og utvikler produkter. Majoriteten av våre produkter er tilvirket i massiv messing med en overflatebehandling. Overflatebehandlingen gjør produktene mere motstandsdyktige og øker holdbarheten. Den høye kvaliteten gjør at produktene holder lengre, og det er derfor helt naturlig for oss å gi 5 og 10 år garanti på alle våre produkter.

FI

### Panostus laatuun

Pitkä käyttöikä ja korkea laatu ovat kaksi isointa rakennuspalikkaa tuotteiden suunnittelussa ja kehityksessä. Suurin osa tuotesarjoistamme on valmistettu massiivimessingistä ja tämän jälkeen käsitelty haluttuun viimeistelyyn. Pintakäsittely tekee tuotteista entistä kestävämpiä käytössä ja pidentää niiden elinikää huomattavasti. Korkea laatu takaa myös sen, että tuotteemme kestävätkin erinomaisesti jatkuvaa käyttöä. Tämän johdosta koemme luonnolliseksi myöntää kaikille tuotteillemme pitkän 10 tai 5 vuoden takuun.

DE

### Fokus auf Qualität

Lange Lebensdauer und hohe Qualität sind zwei der wichtigsten Bestandteile bei der Konzeption und Entwicklung von Produkten. Die meisten unserer Badserien sind aus massivem Messing gefertigt und werden anschließend mit einer speziellen Oberflächenbehandlung versehen. Durch diese Oberflächenbehandlung werden die Produkte noch widerstandsfähiger und langlebiger. Diese Fokussierung auf hohe Qualität ermöglicht eine regelmäßige Nutzung unserer Produkte über einen langen Zeitraum, weshalb wir zuversichtlich sind, auf alle unsere Produkte eine Garantie von 5 bis 10 Jahren geben zu können.

# Up to date

## EN **Be inspired by beautiful black bathroom accessories**

In recent years, black interior details have been increasingly visible in interior design magazines, shops and in our homes. We think that the bathroom should be swept along in the trend. You'll find elegant black matt products in our bathroom series HOME and HOUSE together with complementing DRY towel heater, OUTLINE make-up mirror and SIDELINE shower baskets and squeegees.

## SE **Inspireras av vackra svarta badrumsdetaljer**

De senaste åren har svarta inredningsdetaljer syns allt mer i inredningsmagasin, butiker och i våra hem. Vi tycker att badrummet ska få svepas med i den trenden. Elegant mattsvarta produkter finns nu i väggserie HOME och HOUSE samt i DRY handdukstorkar, OUTLINE speglar och SIDELINE duschkorgar och skrapor.

## DK **Inspireret af smukke sorte badeværelsesdetaljer**

I de senere år er de sorte interiørdetaljer i stigende grad set i interiørdesignmagasiner, butikker og i vores hjem. Vi mener, at badeværelset burde følges op med denne tendens. Elegante matsorte produkter fås nu i HOME og HOUSE serien såvel som i DRY håndklædetørre, OUTLINE spejle og SIDELINE brusekurve og badskrabere.

## NO **Inspiret av vakre detaljer på badet**

De senere årene har sorte interiørdetaljer blitt stadig mere synlig i interiørblader, butikker og i hjemmene våre. Vi synes baderommet skal være med i den trenden. Elegante matte sorte produkter er nå tilgjengelige i HOME og HOUSE veggserien, så vel som i DRY håndkjetørkere, OUTLINE speil og SIDELINE dusjhyller og dusjinaler.

## FI **Kauniita, Mustia Yksityiskohtia Kylpyhuoneeseen**

Mustat sisustustrendit ovat lähiaikoina kasvattaneet suosiotaan sisustuslehdissä, myymälöissä sekä kodeissamme. Me uskomme vakaasti, että kylpyhuoneen tulisi seurata tyylisuuntausta. Eleganteja, mattamustia tuotteita onkin saatavilla jo HOME ja HOUSE tarvikesarjoista, DRY pyyhekuivaimista, OUTLINE meikkipeileistä sekä SIDELINE sarjan suihkukoreista.

## DE **Lassen Sie sich von wunderschönen schwarzen Bad-Accessoires inspirieren.**

In den letzten Jahren wurden schwarze Interieur-Details zunehmend im Innenraum deutlich mehr wahrgenommen, in Zeitschriften, Geschäften und in unseren Wohnräumen. Wir meinen, dass das Badezimmer im Trend mitgenommen werden sollte. Sie werden die elegant schwarz-matten Produkte in unserer Badezimmerreihe HOME und HOUSE zusammen mit dem ergänzenden Handtuchwärmer DRY, dem OUTLINE Make-up-Spiegel, dem SIDELINE Duschkorb und den verschiedenen Duschkabzieher finden.







# AIR



EN AIR is our range where sleek lines meet true elegance, together creating a classic design

SE I AIR möts strikt formspråk med luftig elegans och skapar en tidlös design.

DK I vores AIR serie mødes strengt designsprog, luftig elegance der til sammen skaber et tidløst design.

NO I AIR møtes ett strengt formspråk og en luftig eleganse som skaper ett tidløst design.

FI AIR sarjassa suorat linjat kohtaavat ilmavan eleganssin. Yhdessä nämä muodostavat klassisen designin.

DE AIR ist unsere Serie, in der elegante Formen auf wahre Leichtigkeit treffen und zusammen ein außergewöhnliches Design schaffen.



POLISHED CHROME (AK)



**1 AK320**  
 Spare toilet roll holder  
 Reservpappershållare  
 Reservepapirholder  
 Reserverullholder  
 Varapaperiteline  
 Reservepapierhalter  
 H 170 mm  
 6 3/4"

**2 AK342 \***  
 Soap dish - frosted glass  
 Tvålkopp. Frostet glas  
 Sæbeskål. Materet glas  
 Såpekopp i frostet glass  
 Saippuakupitteline. Kuppi huurrelasia  
 Seifenschale

**3 AK3414**  
 Toilet roll holder with cover  
 Toalettpappershållare med lock  
 Toiletpapirholder med låg  
 Toalettpapirholder med lokk  
 WC-papieriteline kannella  
 Toilettenpapierhalter mit Deckel

**4 AK333 \***  
 Toilet brush  
 WC-börste  
 WC-børste  
 WC-børste  
 WC-harja  
 WC-Bürste  
 H 380 mm  
 15"

**5 AK341**  
 Toilet roll holder  
 Toalettpappershållare  
 Toiletpapirholder  
 Toalettpapirholder  
 WC-papieriteline  
 Toilettenpapierhalter

**6 AK355**  
 Single towel hook  
 Enkelkrok  
 Krog  
 Enkelkrok  
 Pyyhekoukku  
 Handtuchhaken  
 H 47 mm  
 1 7/8"

**7 AK343 \***  
 Glass tumbler - frosted glass  
 Tandborstglas med hållare  
 Holder med tandkrus  
 Tannglass i frostet glass  
 Hammasmukiteline, muki huurrelasia  
 Zahnputzbecher

**8 AK344**  
 Towel ring  
 Handduksring  
 Håndklædering  
 Håndklæring  
 Pyyherengas  
 Handtuchring  
 205 x 170 mm 8" x 6 3/4"

\* Porcelain parts are available separately / Porlinsdelar finns att köpa separat / Porcelændeale kan købes separat  
 Porselensdeler kan kjøpes løst / Posiilinosat ovat saatavilla erikseen / Porzellan-Teile separat erhältlich



1



5



6



2



7



3



4



**1 AK3455**  
Multi-purpose hook, pair  
Enkelkrok, par  
Krog, par  
Enkelkrok, par  
Nuppikoukkupari  
Handtuchhaken, 2 Stück  
D 31 mm / 1 1/2"  
Diam 19 mm / 3/4"

**2 AK325**  
Grab bar  
Badkarshandtag  
Badekarsgreb  
Badekarshåndtak  
Tukikahva  
Wannengriff  
L 300 mm / 11 7/8"

**3 AK3364**  
Double towel rail  
Dubbel handduksstång  
Dobbelt håndklædestang  
Dobbelt håndklestang  
Kaksoispyyhetanko  
Doppelte Handtuchstange  
L 606 mm / 24"

**4 AK3464**  
Single towel rail  
Enkel Handduksstång  
Enkel håndklædestang  
Enkel håndklestang  
Pyyhetanko  
Handtuchstange  
L 606 mm / 24"

**5 AK3411**  
Toilet roll holder  
Toiletpappershållare  
Toiletpapirholder  
Toiletpapirholder  
WC-paperteline  
Toilettenpapierhalter  
L 171 mm / 6 3/4"

**6 AK327**  
Swing arm triple hook  
Svängbar trippelkrok  
Svingbar trippelkrog  
Svingbar trippelkrok  
Kääntyvä kolmoiskoukku  
Schwenkbarer Dreierhaken  
L 127 mm / 5"  
H 95 mm / 3 3/4"

**7 AK323**  
Holder for hairdryer and straightener  
Hållare till hårfön & plåttång  
Holder for hårtorrer og fladtang  
Holder for hårtorrer og rettetang  
Teline hiustenkuivaajalle sekä suoristusraudalle  
Fön- und Glätteisenhalter  
120 x 97 mm. H 20 mm  
4 3/4"W x 4"D x 3/4"H



1



3



4



2

**1 AK369 \***

Glass soap dispenser  
 Tvåldispenser. Insats av glas  
 Sæbedispenser. I materet glas  
 Såpedispenser. I frostatet glass  
 Saippua-annostelija. Pullo huurrelasia  
 Seifenspender. Behälter aus Glas

H 180 mm / 7"

**2 AK347**

Frosted glass shelf - tempered glass  
 Badrumshylla. Hyllan av frostat säkerhetsglas  
 Badeværelseshylde. Hylde i materet glas  
 Baderomshylle. Hylle i frostatet glass  
 Kylpyhuonehylly. Hylly huurrelasia  
 Badezimmerkonsole Sicherheitsglas matt

L 600 mm / 24"

**3 AK374**

Soap basket  
 Tvålkorg  
 Brusekurv  
 Enkel dusjkurv  
 Saippukori  
 Seifenkorb

250 x 103 mm. H 60 mm  
 10"W X 3"H X 3 3/4"D

**4 AK326**

Swing arm towel rail  
 Svängbar handduksstång  
 Svängbar håndklædestang  
 Svängbar håndklestang  
 Kääntyvä kaksoispyyhetanko  
 Schwenkbare Handtuchstange

L 440 mm / 17"



# DRY



- EN The classic lines in our DRY towel warmers brings style to every bathroom. With practical hang-on products.
- SE De enkla linjerna i våra DRY handduktorkar ger stil åt varje badrum. Till hängarna finns flera praktiska tillbehör.
- DK De enkle linjer i vores DRY håndklædetørrer giver stil til ethvert badeværelse. Der findes flere praktiske detaljer som tilbehør til håndklædetørrende.
- NO De enkle linjene på våre DRY håndletørkere gir stil til ethvert baderom. Her finnes praktisk tilbehør.
- FI DRY pyyhekuivaimien klassiset linjat tuovat tyylikkyyden jokaiseen kylpyhuoneeseen. Saatavilla myös käytännöllisiä lisävarusteita.
- DE Die klassischen Formen unserer Handtuchwärmer DRY bringen Eleganz in jedes Badezimmer. Mit praktischen zusätzlichen Hängeprodukten.



STAINLESS STEEL POLISHED (FK)  
BLACK (FB)  
WHITE (FX)

1



**1 FK701**  
 Heated towel rail, tall  
 Handdukstork, hög  
 Håndklædetørrer, høj  
 Håndkletørker, høy  
 Pyyhekuivain, korkea  
 Handtuchwärmer, hoch  
 500 X 1212 X 112 mm  
 120W. 220-240 V AC. 50Hz  
 Class 1, IP44. Max 55°C

**2 FK702**  
 Heated towel rail, wide  
 Handdukstork, bred  
 Håndklædetørrer, bred  
 Håndkletørker, bred  
 Pyyhekuivain, leveä  
 Handtuchwärmer, breit  
 1000 x 480 x 112 mm  
 90W. 220-240 V AC. 50Hz  
 Class 1, IP44. Max 55°C

2



3



**3 FK700**  
 Heated towel rail, compact  
 Handdukstork, kompakt  
 Håndklædetørrer, kompakt  
 Håndkletørker, kompakt  
 Pyyhekuivain, kompakti  
 Handtuchwärmer, kompakt  
 500 x 689 x 112 mm  
 65W. 220-240 V AC. 50Hz  
 Class 1, IP44. Max 55°C

**4 FB700**  
 Heated towel rail, compact  
 Handdukstork, kompakt  
 Håndklædetørrer, kompakt  
 Håndkletørker, kompakt  
 Pyyhekuivain, kompakti  
 Handtuchwärmer, kompakt  
 500 x 689 x 112 mm  
 74W. 220-240 V AC. 50Hz  
 Class 1, IP44. Max 55°C

4



5



**5 FK717**  
 Heated towel rail 4 swivel arms  
 Handdukstork, 4-armad svängbar  
 Håndklædetørrer, 4-armet  
 Håndkletørker, 4 svingbare armer  
 Pyyheteline. 4 kääntyvää tankoa  
 Schwenkbare Handtuchwärmer  
 403 x 777 x 87 mm  
 40W. 220-240 V AC. 50Hz  
 Class 1, IP44. Max 55°C

1



Timer 2/4 H

2



3



4



**1 FK706**  
 Heated towel rail, tall  
 Handdukstork, hög  
 Håndklædetørrer, høj  
 Håndkletørker, høy  
 Pyyhekuivain, korkea  
 Handtuchwärmer, hoch  
 Timer 2/4 H  
 500 x 1212 x 112 mm  
 65W. 220-240 V AC. 50Hz  
 Class 1, IP44. Max 55°C

**2 FK705**  
 Heated towel rail, compact  
 Handdukstork, kompakt  
 Håndklædetørrer, kompakt  
 Håndkletørker, kompakt  
 Pyyhekuivain, kompakti  
 Handtuchwärmer, kompakt  
 Timer 2/4 H  
 500 x 689 x 112 mm  
 40W. 220-240 V AC. 50Hz  
 Class 1, IP44. Max 55°C

**3 FK707**  
 Heated towel rail, S  
 Handdukstork, S  
 Håndklædetørrer, S  
 Håndkletørker, S  
 Pyyhekuivain, S  
 Handtuchwärmer, S  
 500 x 525 x 112 mm  
 50W. 220-240 V AC. 50Hz  
 Class 1, IP44. Max 55°C

**4 FK716**  
 Heated towel rail, tree  
 Handdukstork, träd  
 Håndklædetørrer, træ  
 Håndkletørker, tre  
 Pyyhekuivain, pylväs  
 Handtuchwärmer, Baum  
 1700 x 80 mm  
 30W. 220-240 V AC. 50Hz  
 Class 1, IP44. Max 55°C

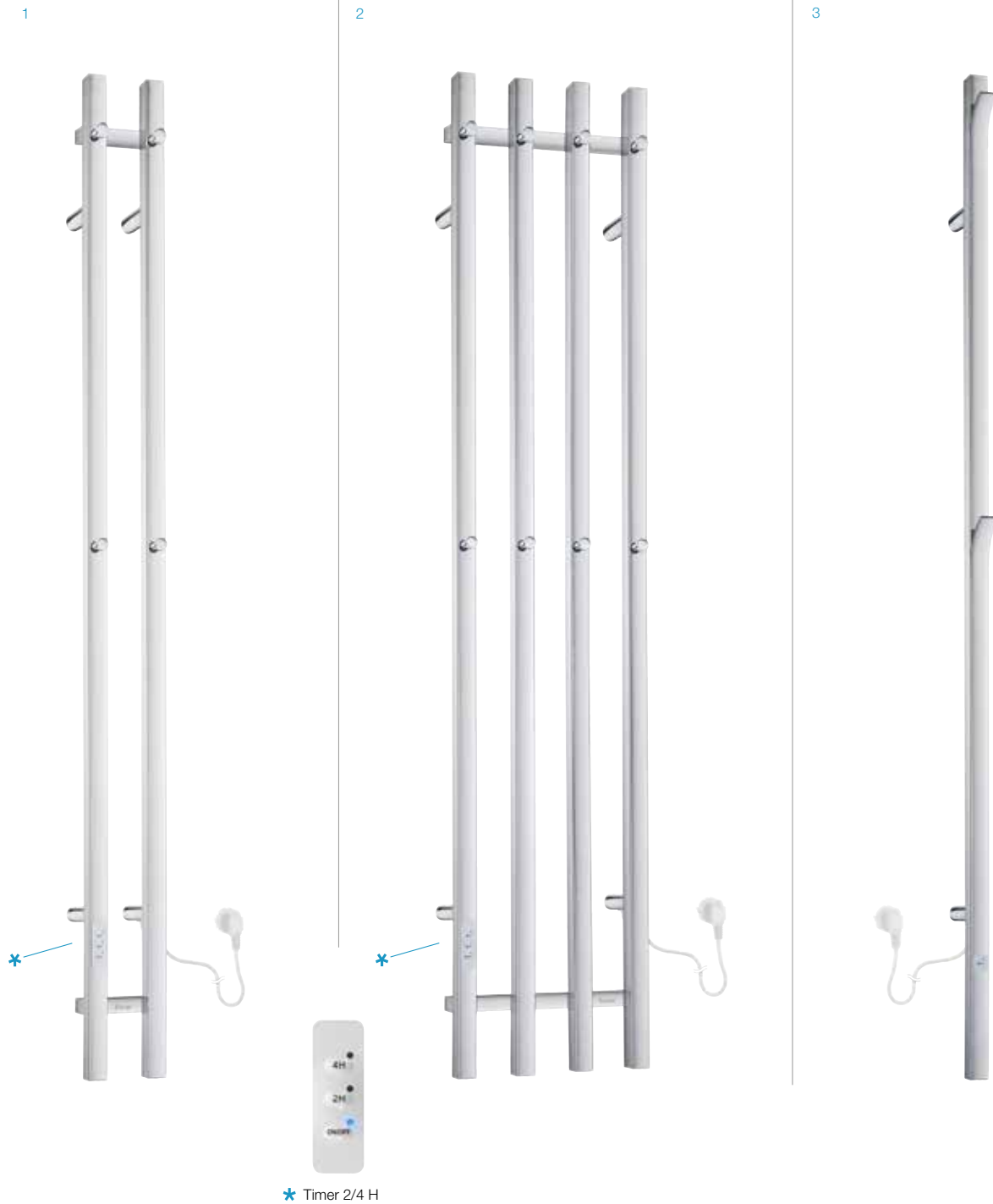

**1 FK712**  
 Heated towel rail, vertical  
 Handdukstork, vertikal  
 Håndklædetørrer, lodret  
 Håndkletørker, vertikal  
 Pyyhekuivain, pystysuora  
 Handtuchwärmer, vertikal  
 Timer 2/4 H  
 120 x 1500 mm  
 60W. 220-240 V AC. 50Hz  
 Class 1, IP44. Max 55°C

**2 FK714**  
 Heated towel rail, vertical  
 Handdukstork, vertikal  
 Håndklædetørrer, lodret  
 Håndkletørker, vertikal  
 Pyyhekuivain, pystysuora  
 Handtuchwärmer, vertikal  
 Timer 2/4 H  
 300 x 1500 mm  
 120W. 220-240 V AC. 50Hz  
 Class 1, IP44. Max 55°C

**3 FK715**  
 Heated towel rail, vertical  
 Handdukstork, vertikal  
 Håndklædetørrer, lodret  
 Håndkletørker, vertikal  
 Pyyhekuivain, pystysuora  
 Handtuchwärmer, vertikal  
 30 x 1500 mm  
 25W. 220-240 V AC. 50Hz  
 Class 1, IP44. Max 55°C



1



2



3



4



5

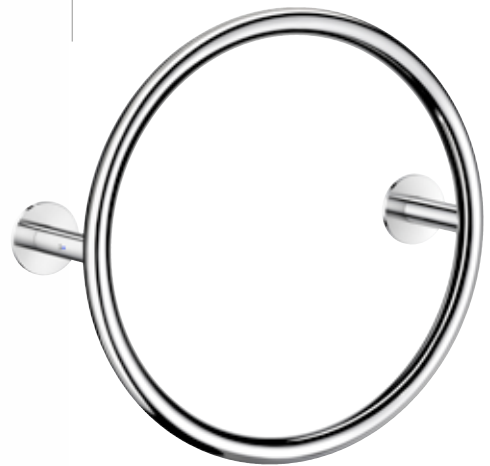

**1 FB710**  
Heated towel rail, tree  
Handdukstork, träd  
Håndklædetorrer, træ  
Håndkletørker, tre  
Pyyhekuivain, pylväs  
Handtuchwärmer, Baum

1720 x 80 mm

31W. 220-240 V AC. 50Hz  
Class 1, IP44. Max 55°C

**2 FX710**  
Heated towel rail, tree  
Handdukstork, träd  
Håndklædetorrer, træ  
Håndkletørker, tre  
Pyyhekuivain, pylväs  
Handtuchwärmer, Baum

1720 x 80 mm

31W. 220-240 V ac. 50Hz  
Class 1, IP44. Max 55°C

**3 FK710**  
Heated towel rail, tree  
Handdukstork, träd  
Håndklædetorrer, træ  
Håndkletørker, tre  
Pyyhekuivain, pylväs  
Handtuchwärmer, Baum

1720 x 80 mm

25W. 220-240 V AC. 50Hz  
Class 1, IP44. Max 55°C

**4 FK711**  
Heated towel rail, tree  
Handdukstork, träd  
Håndklædetorrer, træ  
Håndkletørker, tre  
Pyyhekuivain, pylväs  
Handtuchwärmer, Baum

900 x 80 mm

11W. 220-240 V AC. 50Hz  
Class 1, IP44. Max 55°C

**5 FK718**  
Heated towel rail, circle  
Handdukstork, cirkel  
Håndklædetorrer, cirkel  
Håndkletørker, cirkel  
Pyyhekuivain, ympyrä  
Handtuchwärmer, Kreis

Ø 500 mm

31W. 220-240 V ac. 55Hz  
Class 1, IP44. Max 55°C





**1 FK100**  
Single towel hook, pair  
Enkel handdukskrok, par  
Krog, par  
Enkelkrok, par  
Koukkupari  
Handtuchhaken, 2 Stück  
H 75 x D 51 x W 22 mm  
3"H x 7/8"W x 2 1/6"D

**2 FK120**  
Double towel hook  
Dubbel handdukskrok  
Dobbelt krog  
Dobbel krok  
Kaksoispyyhekoukku  
Doppelter Handtuchhaken  
H 76 x W 82 x D 35 mm  
3"H x 3 1/4"W x 1 7/16"D



Mounting kit for electrical hardwiring  
Monteringsatts för dold el-anlutning  
Monteringsinsats skjult el-tillslutning  
Monteringssett til skjult el-tilkobling  
Asennussarja kiinteään sähköasennukseen  
Montage- Kit für verdeckte Elektroanschluss

**4 FX721 = FX710**

**5 FB720 = FB700 / FB721 = FB710**

**6 FK722 = FK705 - FK707**

**7 FK724 = FK716**

**8 FK720 = FK700 - FK702  
FK721 = FK710 - FK711  
FK723 = FK712 - FK715  
FK725 = FK717**



**3 FK130**  
Quadruple towel hook  
Fyrkrok  
Firekrog  
Kroklis, 4 kroker  
Nelikoukku  
Viererhaken  
H 154 x W 91 x D 53 mm  
6 1/8"H x 3 5/8"W x 2 1/8"D

**9 FK140**  
Single hook, pair  
Enkel handdukskrok, par  
Krog, par  
Enkelkrok, par  
Koukkupari  
Handtuchhaken, 2 Stück  
H 73 x W 30 x D 41 mm  
2 7/8"H x 1 3/16"W x 1 5/8"D

**10 FK170**  
Single hook, pair  
Enkel handdukskrok, par  
Krog, par  
Enkelkrok, par  
Koukkupari  
Handtuchhaken, 2 Stück  
H 70 x W 20 x D 30 mm  
2 13/16"H x 13/16"W x 1 3/16"D

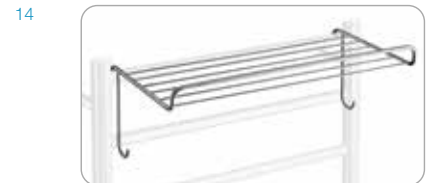
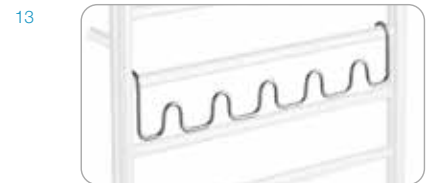

**11 FK730**  
Hooks, pair  
Krokar, par  
Håndklædekrog, par  
Håndlekrok, par  
Koukut, pari  
Haken, 2 Stück  
22 x 64 x 52 mm

**12 FK731**  
Large hook  
Stor krok  
Håndklædekrog  
Håndlekrok  
Koukku kylppyypyhkeelle  
Badetuchhaken  
145 mm

**13 FK732**  
Multi hook  
Multikrok  
Multikrog  
Multikrok  
Monikäyttökoukku  
MultiHaken  
427 X 107 mm

**14 FK737 \***  
Rack  
Hylla  
Hylde  
Hylle  
Hylly  
Ablage  
427 x 174 x 223 mm

\* Not suitable for FK705-FK707  
Passar inte till FK705-FK707  
Ikke egnet til FK705-FK707  
Passer ikke til FK705-FK707  
Ei SOVELLU FK705-FK707  
Nicht geeignet für FK705-FK707



# HOME



- EN HOME is the result of minimalism and simplicity combined in a clean and functional range.
- SE HOME är resultatet av enkel och vacker formgivning med funktion och känsla.
- DK HOME serien er resultatet af et simpelt og smukt design med funktion og fornemmelse.
- NO HOME er resultatet av ren og vakker formgivning med funksjon og følelse.
- FI HOME sarjassa kohtaavat yksinkertainen ja minimalistinen design, sekä puhtas toiminnallisuus.
- DE HOME ist das Resultat von Minimalismus und Schlichtheit, kombiniert in einem übersichtlichen und funktionsorientierten Programm.



BLACK (HB)  
POLISHED CHROME (HK)  
BRUSHED CHROME (HS)  
BRUSHED BRASS (HV)

1



2



3



**1 HK3414 / HS3414**  
Toilet roll holder with cover  
Toalettpappershållare med lock  
Toiletpapirholder med låg  
Toalettpapirholder med lokk  
WC-paperteline kannella  
Toilettenpapierhalter mit Deckel

**2 HK341 / HS341**  
Toilet roll holder  
Toalettpappershållare  
Toiletpapirholder  
Toalettpapirholder  
WC-paperteline  
Toilettenpapierhalter

**3 HK320 / HS320**  
Spare toilet roll holder  
Reservpappershållare  
Reservpapirholder  
Reserverullholder  
Varapaperteline  
Reservpapierhalter  
H 140 mm / 5 1/2"

4



5



6



**4 HK343 / HS343**  
Glass tumbler - frosted glass  
Tandborstglas med hållare  
Holder med tandkrus  
Tannnglass i frostet glass  
Hammasmukiteline, muki huurrelasia  
Zahnputzbecher

**5 HK361**  
Glass soap dispenser  
Tvåldispenser. Insats av glas  
Sæbedispenser. I materet glas  
Såpedispenser. I frostet glass  
Saippua-annostelija. Pullo huurrelasia  
Seifenspender. Behälter aus Glas  
H 120 mm / 4 23/32"

**6 HK342 / HS342**  
Soap dish - frosted glass  
Tvälkopp. Frostet glas  
Sæbeskål. Materet glas.  
Såpekopp i frostet glass  
Saippuakupittelina. Kuppi huurrelasia  
Seifenschale

7



8



**7 HK369 / HS369**  
Glass soap dispenser  
Tvåldispenser. Insats av glas  
Sæbedispenser. I materet glas  
Såpedispenser. I frostet glass  
Saippua-annostelija. Pullo huurrelasia  
Seifenspender. Behälter aus Glas  
H 180 mm / 7"

**8 HK333 / HS333**  
Toilet brush  
WC-borste  
WC-børste  
WC-børste  
WC-harja  
WC-Bürste  
H 380 mm / 15"

1



2



3



4



5



6



7

**1 HK343P**

Holder with porcelain tumbler  
 Tandborstglas. Insats av porslin  
 Tandkrus. I porcelæn  
 Tannglass i porselen  
 Hammasmukiteline. Muki posliini  
 Zahnputzbecher, Becher aus Porzellan  
 H 98 mm / 3 7/8"

**2 HK3411 / HS3411**

Toilet roll holder  
 Toalettpappershållare  
 Toiletpapirholder  
 Toalettpapirholder  
 WC-paperiteline  
 Toilettenpapierhalter  
 L 152 mm / 6"

**3 HK369P**

Porcelain soap dispenser  
 Tvåldispenser. Insats av porslin  
 Sæbedispenser. I porcelæn  
 Såpedispenser. Beholder av porselen  
 Saippua-annostelija. Posliini  
 Seifenspender. Behälter aus Porzellan  
 H 180 mm / 7 1/16"

**4 HK332 / HS332**

Toilet brush  
 WC-børste  
 WC-børste  
 WC-børste  
 WC-Harja  
 WC-Bürste  
 H 390 mm / 15 3/8"

**5 HK342P**

Soap dish - porcelain  
 Tvålkopp. Insats av porslin  
 Sæbeskål. I porcelæn  
 Såpekopp i porselen  
 Saippuakuppiteline. Posliini  
 Seifenschale aus Porzellan

**6 HK370 / HS370**

Chrome soap dispenser  
 Tvåldispenser  
 Sæbedispenser  
 Såpedispenser  
 Saippua-annostelija  
 Seifenspender  
 H 160 mm / 6 1/4"

**7 HK333P**

Toilet brush with porcelain tumbler  
 WC-børste. Insats av porslin  
 WC-børste. I porcelæn  
 WC-børste. Beholder av porselen  
 WC-Harja. Posliini  
 WC-Bürste. Behälter aus Porzellan  
 H 380 mm / 14 15/16"

1



2



3



4



5



6

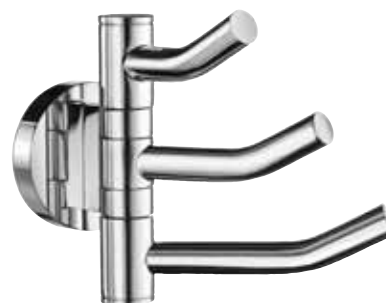

7

**1 HK355 / HS355**

Single towel hook  
Enkelkrok  
Krog  
Enkelkrok  
Pyyhekoukku  
Handtuchhaken

Ø 48 mm / 1 7/8"

**2 HK356 / HS356**

Double towel hook  
Dubbel badlakanskrok  
Dobbelt krog  
Dobbelt krok  
Kaksoispyyhekoukku  
Doppelter Badetuchhaken

L 90 mm / 3 1/2"

**3 HK359 / HS359**

Quadruple hook  
Fyrkrok  
Firekrog  
Kroklist, 4 kroker  
Nelikkoukusarja  
Viererhakenleiste

L 178 mm / 7"

**4 HK3455 / HS3455**

Towel hook, pair  
Enkelkrok, par  
Krog, par  
Enkelkrok, par  
Nuppikoukkupari  
Handtuchhaken, 2 Stück

D 25 mm / 1"

**5 HK358 / HS358**

Bath robe hook  
Badrockskrok  
Badekåbe krog  
Krok for badekåpe  
Kylpytakkikoukku  
Bademantelhaken

H 135 mm / 5 1/3"

**6 HK377 / HS377**

Corner soap basket - two levels  
Hörntvålkorg, dubbel  
Dobbelt hjørne brusekurv  
Dobbelt hjørnedusjkurv  
Kaksois-saippuakori  
Seifenkorb, doppelt

207 X 207 mm. H 295 mm  
8 1/8"W x 11 5/8"H x 8 1/8"D

**7 HK327 / HS327**

Swing arm triple hook  
Svängbar trippelkrok  
Svingbar trippelkrok  
Svingbar trippelkrok  
Kääntyvä kolmoiskoukku  
Schwenkbarer Dreierhaken

H 90 mm / 3 1/2"



**1 HK325 / HS325**  
 Grab bar  
 Badkarshandtag  
 Badekarsgreb  
 Badekarshåndtak  
 Tukikahva  
 Wannengriff  
 L 284 mm / 11 1/4"

**2 HK3464 / HS3464**  
 Single towel rail  
 Enkel handduksstång  
 Enkel håndklædestang  
 Enkel håndklestang  
 Pyyhetanko  
 Handtuchstange  
 L 648 mm, cc 600 mm / 25 1/2"

**3 HK3364 / HS3364**  
 Double towel rail  
 Dubbel handduksstång  
 Dobbelt håndklædestang  
 Dobbelt håndklestang  
 Kaksoispyyhetanko  
 Doppelte Handtuchstange  
 L 648 mm, cc 600 mm / 25 1/2"

**4 HK347 / HS347**  
 Frosted glass shelf - tempered glass  
 Badrumshylla. Hyllan av frostat säkerhetsglas  
 Badeværelshylde. Hylde i materet glas.  
 Baderomshylle. Hylle i frostat glass  
 Kylpyhuonehylly. Hylly huurrelasia  
 Badezimmerkonsole Sicherheitsglas matt  
 L 600 mm / 24"

**5 HK328 / HS328**  
 Towel rail  
 Enkel handduksstång  
 Enkel håndklædestang  
 Enkel håndklestang  
 Pyyhetanko  
 Handtuchstange  
 L 430 mm / 16 7/8"

**6 HK326 / HS326**  
 Swing arm towel rail  
 Svängbar handduksstång  
 Svingbar håndklædestang  
 Svingbar håndklestang  
 Kääntyvä kaksoispyyhetanko  
 Schwenkbare Handtuchstange  
 L 440 mm / 17 1/2"

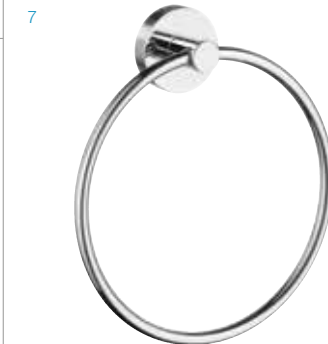

**7 HK344 / HS344**  
 Towel ring  
 Handduksring  
 Håndklædering  
 Håndklæring  
 Pyyherengas  
 Handtuchring  
 Ø 170 mm / 8 3/4"

**8 HK323 / HS323**  
 Holder for hairdryer  
 Hållare till hårfön  
 Holder for hårtorrer  
 Holder for hårtorrer  
 Hiustenkuivaajan pidike  
 Fönhalter  
 H 155 mm / 6 1/8"  
 Ø 90 mm / 60 mm / 3 1/2" / 2 1/2"

**9 HK3231 / HS3231**  
 Holder for hairdryer and straightener  
 Hållare till hårfön och plattång  
 Holder for hårtorrer og fladtang  
 Holder for hårtorrer og rettetang  
 Hiustenkuivaajan pidike  
 Fönhalter  
 L 129 mm / 5"

1



2



3



4



5



6



7



8



**1 HB341**  
Toilet roll holder  
Toalettpappershållare  
Toiletpapirholder  
Toalettpapirholder  
WC-paperiteline  
Toilettenpapierhalter

**2 HB361**  
Glass soap dispenser  
Tvåldispenser. Insats av glas  
Sæbedispenser. I materet glas  
Såpedispenser. I frostet glass  
Saippua-annostelija. Pullo huurrelasia  
Seifenspender. Behälter aus Glas  
H 120 mm / 4 23/32"

**3 HB320**  
Spare toilet roll holder  
Reservpappershållare  
Reservpapirholder  
Reserverullholder  
Varapaperiteline  
Reservpapierhalter  
H 140 mm / 5 1/2"

**4 HB3411**  
Toilet roll holder  
Toalettpappershållare  
Toiletpapirholder  
Toalettpapirholder  
WC-paperiteline  
Toilettenpapierhalter  
L152 mm / 6"

**5 HB332**  
Toilet brush  
WC-borste  
WC-børste  
WC-børste  
WC-Harja  
WC-Bürste  
H 390 mm / 15 3/8"

**6 HB359**  
Quadruple hook  
Fyrkrok  
Firekrog  
Kroklist, 4 kroker  
Nelikoukkusarja  
Viererhakenleiste  
L 178 mm / 7"

**7 HBS3455**  
Towel hook, pair  
Enkelkrok, par  
Krog, par  
Enkelkrok, par  
Nuppikoukkupari  
Handtuchhaken, 2 Stück  
D 25 mm / 1"

**8 HB369P**  
Porcelain soap dispenser  
Tvåldispenser. Insats av porslin  
Sæbedispenser. I porcelæn  
Såpedispenser. Beholder av porselen  
Saippua-annostelija. Posliini  
Seifenspender. Behälter aus Porzellan  
H 180 mm / 7 1/16"



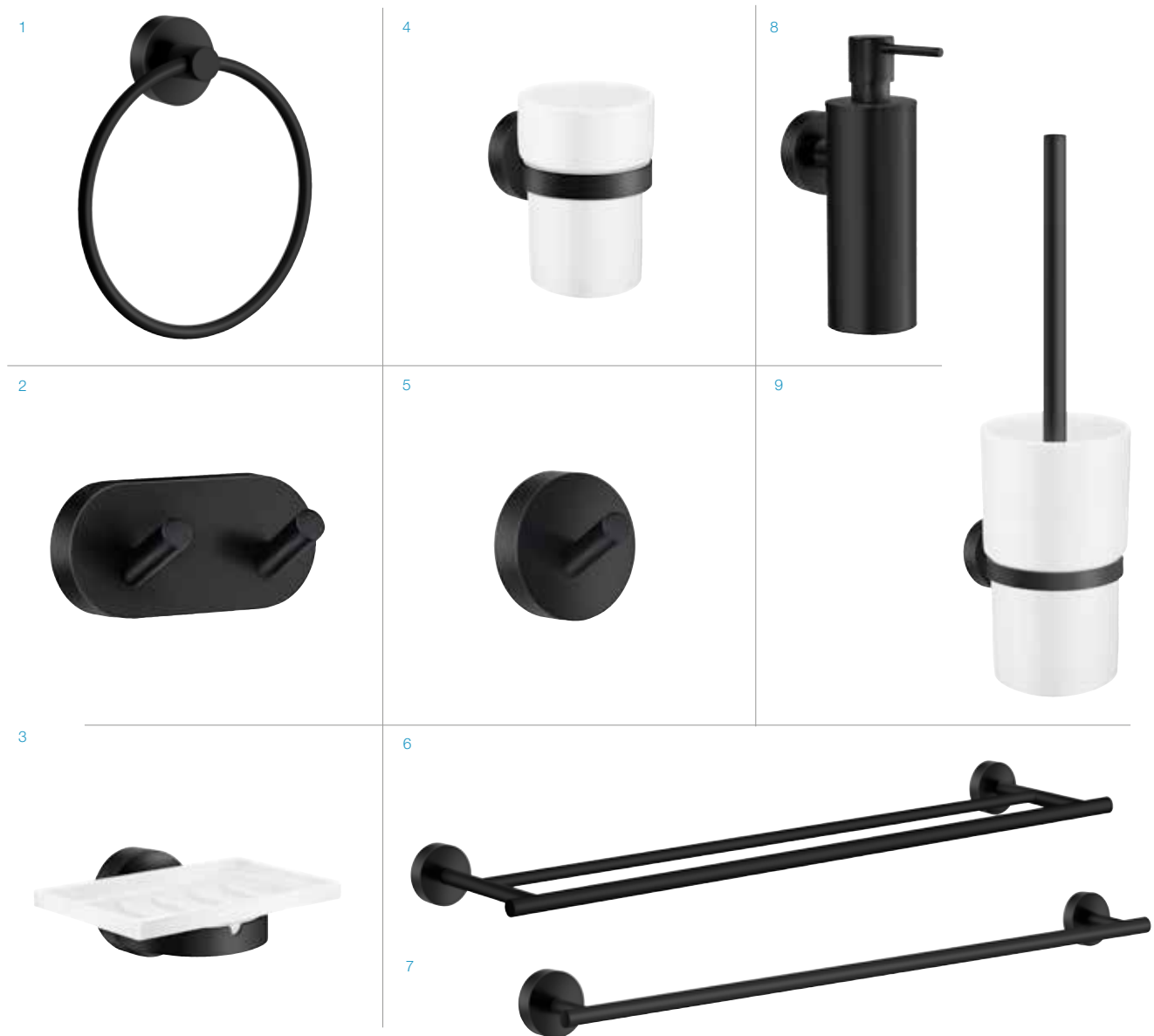

- 1 HB344**  
Towel ring  
Handduksring  
Håndklædering  
Håndklæring  
Pyyherengas  
Handtuchring  
Ø 170 mm / 8 3/4"
- 2 HB356**  
Double towel hook  
Dubbel badlakanskrok  
Dobbelt krog  
Dobbel krok  
Kaksoispyyhökoukku  
Doppelter Badetuchhaken  
L 90 mm / 3 1/2"
- 3 HB342P**  
Soap dish - porcelain  
Tvålkopp. Insats av porslin  
Sæbeskål. I porcelæn  
Såpekopp i porselen  
Saippuakupitteline. Posliini  
Seifenschale aus Porzellan

- 4 HB343P**  
Holder with porcelain tumbler  
Tandborstglas. Insats av porslin  
Tandkrus. I porcelæn  
Tannglass i porselen  
Hammasmukitelaine. Muki posliini  
Zahnputzbecher, Becher aus Porzellan  
H 98 mm / 3 7/8"
- 5 HB355**  
Single towel hook  
Enkelkrok  
Krog  
Enkelkrok  
Pyyhekoukku  
Handtuchhaken  
Ø 48 mm / 1 7/8"
- 6 HB3364**  
Double towel rail  
Dubbel handduksstång  
Dobbelt håndklædestang  
Dobbel håndklestang  
Kaksoispyyhetanko  
Doppelte Handtuchstange  
L 648 mm, cc 600 mm / 25 1/2"

- 7 HB3464**  
Single towel rail  
Enkel handduksstång  
Enkel håndklædestang  
Enkel håndklestang  
Pyyhetanko  
Handtuchstange  
L 648 mm, cc 600 mm / 25 1/2"
- 8 HB370**  
Soap dispenser  
Tvåldispenser  
Sæbedispenser  
Såpedispenser  
Saippua-annostelija  
Seifenspender  
H 160 mm / 6 1/4"
- 9 HB333P**  
Toilet brush with porcelain tumbler  
WC-borste. Insats av porslin  
WC-børste. I porcelæn  
WC-børste. Beholder av porselen  
WC-Harja. Posliini  
WC-Bürste. Behälter aus Porzellan  
H 380 mm / 14 15/16"

1



4



6



2



5



7



3



8

**1 HV341**

Toilet roll holder  
Toalettpappershållare  
Toiletpapirholder  
Toalettpapirholder  
WC-paperiteline  
Toilettenpapierhalter

**2 HV361**

Glass soap dispenser  
Tvåldispenser. Insats av glas  
Sæbedispenser. I materet glas  
Såpedispenser. I frostet glass  
Saippua-annostelija. Pullo huurrelasia  
Seifenspender. Behälter aus Glas  
H 120 mm / 4 23/32"

**3 HV320**

Spare toilet roll holder  
Reservpappershållare  
Reservpapirholder  
Reservrollholder  
Varapaperiteline  
Reservpapierhalter  
H 140 mm / 5 1/2"

**4 HV3411**

Toilet roll holder  
Toalettpappershållare  
Toiletpapirholder  
Toalettpapirholder  
WC-paperiteline  
Toilettenpapierhalter  
L152 mm / 6"

**5 HV332**

Toilet brush  
WC-borste  
WC-børste  
WC-børste  
WC-Harja  
WC-Bürste  
H 390 mm / 15 3/8"

**6 HV359**

Quadruple hook  
Fyrkrok  
Firekrog  
Kroklis, 4 kroker  
Nelikkoukkusarja  
Viererhakenleiste  
L 178 mm / 7"

**7 HV3455**

Towel hook, pair  
Enkelkrok, par  
Krog, par  
Enkelkrok, par  
Nuppikoukkupari  
Handtuchhaken, 2 Stück  
D 25 mm / 1"

**8 HV369P**

Porcelain soap dispenser  
Tvåldispenser. Insats av porslin  
Sæbedispenser. I porcelæn  
Såpedispenser. Beholder av porselen  
Saippua-annostelija. Posliini  
Seifenspender. Behälter aus Porzellan  
H 180 mm / 7 1/16"

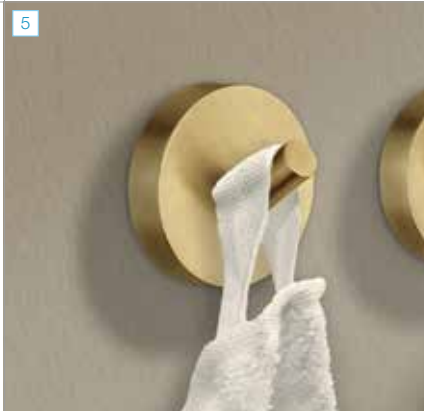

- 1 HV344**  
Towel ring  
Handduksring  
Håndklædering  
Håndklæring  
Pyyherengas  
Handtuchring  
Ø 170 mm / 8 3/4"
- 2 HV356**  
Double towel hook  
Dubbel badlakanskrok  
Dobbelt krog  
Dobbel krok  
Kaksoispyyhekoukku  
Doppelter Badetuchhaken  
L 90 mm / 3 1/2"
- 3 HV342P**  
Soap dish - porcelain  
Tvålkopp. Insats av porslin  
Sæbeskål. I porcelæn  
Såpekopp i porselen  
Saippuakupitteline. Posliini  
Seifenschale aus Porzellan

- 4 HV343P**  
Holder with porcelain tumbler  
Tandborstglas. Insats av porslin  
Tandkrus. I porcelæn  
Tannglass i porselen  
Hammasmukitelaine. Muki posliini  
Zahnputzbecher, Becher aus Porzellan  
H 98 mm / 3 7/8"
- 5 HV355**  
Single towel hook  
Enkelkrok  
Krog  
Enkelkrok  
Pyyhekoukku  
Handtuchhaken  
Ø 48 mm / 1 7/8"
- 6 HV3364**  
Double towel rail  
Dubbel handduksstång  
Dobbelt håndklædestang  
Dobbel håndklestang  
Kaksoispyyhetanko  
Doppelte Handtuchstange  
L 648 mm, cc 600 mm / 25 1/2"

- 7 HV3464**  
Single towel rail  
Enkel handduksstång  
Enkel håndklædestang  
Enkel håndklestang  
Pyyhetanko  
Handtuchstange  
L 648 mm, cc 600 mm / 25 1/2"
- 8 HV370**  
Soap dispenser  
Tvåldispenser  
Sæbedispenser  
Såpedispenser  
Saippua-annostelija  
Seifenspender  
H 160 mm / 6 1/4"
- 9 HV333P**  
Toilet brush with porcelain tumbler  
WC-børste. Insats av porslin  
WC-børste. I porcelæn  
WC-børste. Beholder av porselen  
WC-Harja. Posliini  
WC-Bürste. Behälter aus Porzellan  
H 380 mm / 14 15/16"



# HOUSE



- EN In HOUSE we combine the angular form of the mounting plate with the soft curves of each functional part to create one of our most popular series.
- SE I HOUSE kombineras den kantiga bakplattan med formen av de mjuka och rena detaljerna och skapar en av våra mest omtäckta serier.
- DK I HOUSE kombineres den kantede bagplade med formen på de bløde og rene detaljer og skaber en af vores mest populære serier.
- NO I HOUSE kombineres den kantete bakplaten med formen av de myke og rene detaljene som skaper en av våre best likte serier.
- FI HOUSE sarjassa yhdistämme kantikkaan taustalevyn pyöreiden ja pehmeiden toiminnallisten osien kanssa. Lopputuloksena on yksi suosituimmista sarjoistamme.
- DE Im HOUSE kombinieren wir die eckige Struktur der Wandplatte mit den weichen Formen der einzelnen Funktionsteile zu einer unserer beliebtesten Serien.



POLISHED CHROME (RK)  
BRUSHED CHROME (RS)  
POLISHED BRASS (RV)  
BLACK (RB)  
WHITE (RX)

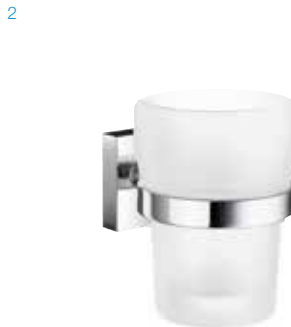

**1 RK369 / RS369**  
Glass soap dispenser  
Tvåldispenser. Insats av glas  
Sæbedispenser. I materet glas  
Såpedispenser. I frostat glass  
Saippua-annostelija. Pullo huurrelasia  
Seifenspender. Behälter aus Glas  
H 180 mm / 7"

**2 RK343 / RS343**  
Glass tumbler - frosted glass  
Tandborstglas med hållare  
Holder med tandkrus  
Tannglass i frostat glass  
Hammasmukiteline, muki huurrelasia  
Zahnputzbecher

**3 RK342 / RS342**  
Soap dish - frosted glass  
Tvålkopp. Frostat glas  
Sæbeskål. Materet glas.  
Såpekopp i frostat glass  
Saippuakupitteline. Kuppi huurrelasia  
Seifenschale

**4 RK370 / RS370**  
Chrome soap dispenser  
Tvåldispenser  
Sæbedispenser  
Såpedispenser  
Saippua-annostelija  
Seifenspender  
H 160 mm / 6 1/4"

**5 RK333 / RS333**  
Toilet brush  
WC-borste  
WC-børste  
WC-børste  
WC-harja  
WC-Bürste  
H 380 mm / 15"

**6 RK332/ RS332**  
Toilet brush  
WC-borste  
WC-børste  
WC-børste  
WC-Harja  
WC-Bürste  
H 390 mm / 15 3/8"

**7 RK361**  
Glass soap dispenser  
Tvåldispenser. Insats av glas  
Sæbedispenser. I materet glas  
Såpedispenser. I frostat glass  
Saippua-annostelija. Pullo huurrelasia  
Seifenspender. Behälter aus Glas  
H 120 mm / 4 23/32"

**8 RK341 / RS341**  
Toilet roll holder  
Toalettpappershållare  
Toiletpapirholder  
Toalettpapirholder  
WC-paperiteline  
Toilettenpapierhalter

**9 RK3414 / RS3414**  
Toilet roll holder with cover  
Toalettpappershållare med lock  
Toiletpapirholder med låg  
Toalettpapirholder med lokk  
WC-paperiteline kannella  
Toilettenpapierhalter mit Deckel

1



4



6



2

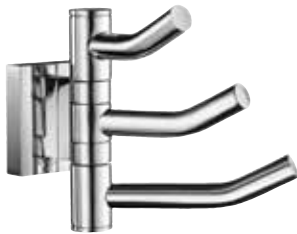

5



7



3



- 1 RK320 / RS320**  
Spare toilet roll holder  
Reservpappershållare  
Reservpapierholder  
Reserverullholder  
Varapaperiteline  
Reservpapierhalter  
H 140 mm / 5 1/2"
- 2 RK327 / RS327**  
Swing arm triple hook  
Svängbar trippelkrok  
Svingbar trippelkrog  
Svingbar trippelkrok  
Kääntyvä kolmoiskoukku  
Schwenkbarer Dreierhaken  
H 90 mm / 3 1/2"
- 3 RK342P**  
Soap dish - porcelain  
Tvålkopp. Insats av porslin  
Sæbeskål. I porcelæn  
Såpekopp i porselen  
Saippuakupitteline. Posliini  
Seifenschale aus Porzellan

- 4 RK3411 / RS3411**  
Toilet roll holder  
Toalettpappershållare  
Toilettpapierholder  
Toalettpapirholder  
WC-paperiteline  
Toilettenpapierhalter  
L 152 mm / 6"
- 5 RK333P**  
Toilet brush with porcelain tumbler  
WC-borste. Insats av porslin  
WC-børste. I porcelæn  
WC-børste. Beholder av porselen  
WC-Harja. Posliini  
WC-Bürste. Behälter aus Porzellan  
H 380 mm / 14 15/16"

- 6 RK369P**  
Porcelain soap dispenser  
Tvåldispenser. Insats av porslin  
Sæbedispenser. I porcelæn  
Såpedispenser. Beholder av porselen  
Saippua-annostelija. Posliini  
Seifenspendler. Behälter aus Porzellan  
H 180 mm / 7 1/16"
- 7 RK343P**  
Holder with porcelain tumbler  
Tandborstglas. Insats av porslin  
Tandkrus. I porcelæn  
Tannglass i porselen  
Hammasmukiteline. Muki posliini  
Zahnputzbecher, Becher aus Porzellan  
H 98 mm / 3 7/8"

1



4



6



2



7



3



5



**1 RK355 / RS355**  
Single towel hook  
Enkelkrok  
Krog  
Enkelkrok  
Pyyhekoukku  
Handtuchhaken  
45 x 45 mm / 1 7/8" x 1 7/8"

**4 RK344 / RS344**  
Towel ring  
Handduksring  
Håndklædering  
Håndklæring  
Pyyherengas  
Handtuchring  
Ø 170 mm / 8 3/4"

**6 RK356 / RS356**  
Double towel hook  
Dubbel badlakanskrok  
Dobbelt krog  
Dobbel krok  
Kaksoispyyhekoukku  
Doppelter Badetuchhaken  
L 90 mm / 3 1/2"

**2 RK3455 / RS3455**  
Towel hook, pair  
Enkelkrok, par  
Krog, par  
Enkelkrok, par  
Nuppikoukku  
Handtuchhaken, 2 Stück  
D 25 mm / 1"

**5 RK359 / RS359**  
Quadruple hook  
Fyrkrok  
Firekrog  
Kroklist, 4 kroker  
Nelikkoukku  
Viererhakenleiste  
L 178 mm / 7"

**7 RK325 / RS325**  
Grab bar  
Badkarshandtag  
Badekarsgreb  
Badekarshåndtak  
Tukikahva  
Wannengriff  
L 284 mm / 11 1/4"

**3 RK358 / RS358**  
Bath robe hook  
Badrockskrok  
Badekåbe krog  
Krok for badekåpe  
Kylpytakkikoukku  
Bademantelhaken  
H 135 mm / 5 1/3"



1



2



3



- 1 RK377 / RS377**  
 Corner soap basket - two levels  
 Hörntvålörög, dubbel  
 Dobbelt hjørne brusekurv  
 Dobbelt hjørnedusjkurv  
 Kaksois-saippukori  
 Seifenkorb, doppelt  
 207 x 207 mm, H 295 mm  
 8 1/8"W x 11 5/8"H x 8 1/8"D

- 2 RK323 / RS323**  
 Holder for hairdryer  
 Hållare till hårfön  
 Holder for hårtorrer  
 Holder for hårtorrer  
 Hiustenkuivaajan pidike  
 Fönhalter  
 H 155 mm / 6 1/8"  
 Ø 90 mm / 60 mm / 3 1/2" / 2 1/2"

- 3 RK3231 / RS3231**  
 Holder for hairdryer and straightener  
 Hållare till hårfön och plattång  
 Holder for hårtorrer og flatång  
 Holder for hårtorrer og rettetang  
 Hiustenkuivaajan pidike  
 Fönhalter  
 L 129 mm / 5"

4



5

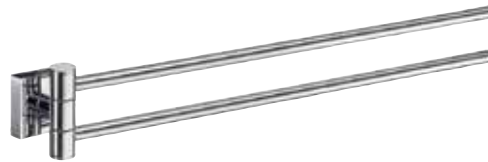

6



7



8



- 4 RK328 / RS328**  
 Towel rail fixed  
 Handduksstång  
 Håndklædestang  
 Håndklestang  
 Käsipyyhetanko  
 Handtuchstange  
 L 430 mm / 16 7/8"

- 5 RK326 / RS326**  
 Swing arm towel rail  
 Svängbar handduksstång  
 Svingbar håndklædestang  
 Svingbar håndklestang  
 Kääntyvä kaksoispyyhetanko  
 Schwenkbare Handtuchstange  
 L 440 mm / 17 1/2"

- 6 RK3464 / RS3464**  
 Single towel rail  
 Enkel Handduksstång  
 Enkel håndklædestang  
 Enkel håndklestang  
 Pyyhetanko  
 Handtuchstange  
 L 648 mm, cc 600 mm / 25 1/2"

- 7 RK3364 / RS3364**  
 Double towel rail  
 Dubbel handduksstång  
 Dobbelt håndklædestang  
 Dobbelt håndklestang  
 Kaksoispyyhetanko  
 Doppelte Handtuchstange  
 L 648 mm, cc 600 mm / 25 1/2"

- 8 RK347 / RS347**  
 Frosted glass shelf - tempered glass  
 Badrumshylla. Hyllan av frostat säkerhetsglas  
 Badeværelseshylde. Hylde i materet glas.  
 Baderomshylle. Hylle i frostet glass  
 Kylpyhuonehylly. Hylly huurrelasia  
 Badezimmerkonsole Sicherheitsglas matt  
 L 600 mm / 24"

1



3



2



5



4



6



**1 RV343P**  
Holder with porcelain tumbler  
Tandborstglas. Insats av porslin  
Holder med tandkrus. I porcelæn  
Tannglass i porselen  
Hammasmukiteline. Muki posliini  
Zahnputzbecher

**2 RV333P**  
Toilet brush with porcelain tumbler  
WC-børste. Insats av porslin  
WC-børste. I porcelæn  
WC-børste. Beholder av porselen  
WC-Harja. Posliini  
WC-Bürste. Behälter aus Porzellan  
H 380 mm / 15"

**3 RV342P**  
Soap dish - porcelain  
Tvålkopp. Insats av porslin  
Sæbeskål. I porcelæn  
Såpekopp i porselen  
Saippuakupitteline. Posiini  
Seifenschale

**4 RV341**  
Toilet roll holder  
Toalettpappershållare  
Toiletpapirholder  
Toiletpapirholder  
WC-paperteline  
Toilettenpapierhalte

**5 RV369P**  
Porcelain soap dispenser  
Tvåldispenser. Insats av porslin  
Sæbedispenser. I porcelæn  
Såpedispenser. I porselen  
Saippua-annostelija. Posliini  
Seifenspender. Behälter aus Porzellan  
H 180 mm / 7"

**6 RV320**  
Spare toilet roll holder  
Reservpappershållare  
Reservepapirholder  
Reserverullholder  
Varapaperteline  
Reservepapirhalter  
H 140 mm / 5 1/2"

1



4



6



2



3



5



- 1 RV355**  
Towel hook  
Enkelkrok  
Krog  
Enkelkrok  
Pyyhekoukku  
Handtuchhaken  
45 x 45 mm / 1 7/8" x 1 7/8"
- 2 RV3464**  
Single towel rail  
Enkel Handduksstång  
Enkel håndklædestang  
Enkel håndklestang  
Pyyhetanko  
Handtuchstange  
L 648 mm , cc 600 mm / 25 1/2"

- 3 RV356**  
Double towel hook  
Dubbel badlakanskrok  
Dobbelt krog  
Dobbelt krok  
Kaksoispyyhekoukku  
Doppelter Badetuchhaken  
L 90 mm / 3 1/2"
- 4 RV3455**  
Towel hook, pair  
Enkelkrok, par  
Krog, par  
Enkelkrok, par  
Nuppikoukkupari  
Handtuchhaken, 2 Stück  
D 25 mm / 1"

- 5 RV359**  
Quadruple hook  
Fyrkrok  
Firekrog  
Kroklist, 4 kroker  
Nelikoukkusarja  
Vierhakenleiste  
L 178 mm / 7"
- 6 RV344**  
Towel ring  
Handduksring  
Håndklædering  
Håndklæring  
Pyyherengas  
Handtuchring  
Ø 170 mm / 8 3/4"

1



4



7



2



5

6



3



8



**1 RB343P**  
Holder with porcelain tumbler  
Tandborstglas. Insats av porslin  
Holder med tandkrus. I porcelæn  
Tannglass i porselen  
Hammasmukitelne. Muki posliini  
Zahnputzbecher

**2 RB369P**  
Porcelain soap dispenser  
Tväldispenser. Insats av porslin  
Sæbedispenser. I porcelæn  
Såpedispenser. I porselen  
Saippua-annostelija. Posliini  
Seifenspender. Behälter aus Porzellan  
H 180 mm / 7"

**3 RB341**  
Toilet roll holder  
Toalettpappershållare  
Toiletpapirholder  
Toalettpapirholder  
WC-paperteline  
Toilettenpapierhalte

**4 RB342P**  
Soap dish - porcelain  
Tvälkopp. Insats av porslin  
Sæbeskål. I porcelæn  
Såpekopp i porselen  
Saippuakupittelne. Posliini  
Seifenschale

**5 RB333P**  
Toilet brush with porcelain tumbler  
WC-børste. Insats av porslin  
WC-børste. I porcelæn  
WC-børste. Beholder av porselen  
WC-Harja. Posliini  
WC-Bürste. Behälter aus Porzellan  
H 380 mm / 15"

**6 RB332**  
Toilet brush  
WC-børste  
WC-børste  
WC-børste  
WC-Harja  
WC-Bürste  
H 390 mm / 15 3/8"

**7 RB370**  
Soap dispenser  
Tväldispenser  
Sæbedispenser  
Såpedispenser  
Saippua-annostelija  
Seifenspender  
H 160 mm / 6 1/4"

**8 RB361**  
Glass soap dispenser  
Tväldispenser. Insats av glas  
Sæbedispenser. I materet glas  
Såpedispenser. I frostet glass  
Saippua-annostelija. Pullu huurrelasia  
Seifenspender. Behälter aus Glas  
H 120 mm / 4 23/32"

1



5



7



2



6



3



8



4



9



1 **RB355**  
Towel hook  
Enkelkrok  
Krog  
Enkelkrok  
Pyyhekoukku  
Handtuchhaken  
45 x 45 mm / 1 7/8" x 1 7/8"

4 **RB3364**  
Double towel rail  
Dubbel handduksstång  
Dobbelt håndklædestang  
Dobbel håndklestang  
Kaksoispyyhetanko  
Doppelte Handtuchstange  
L 648 mm, cc 600 mm / 25 1/2"

7 **RB344**  
Towel ring  
Handduksring  
Håndklædering  
Håndklæring  
Pyyherengas  
Handtuchring  
Ø 170 mm / 8 3/4"

2 **RB356**  
Double towel hook  
Dubbel badlakanskrok  
Dobbelt krog  
Dobbel krok  
Kaksoispyyhekoukku  
Doppelter Badetuchhaken  
L 90 mm / 3 1/2"

5 **RB3455**  
Towel hook, pair  
Enkelkrok, par  
Krog, par  
Enkelkrok, par  
Nuppikoukkupari  
Handtuchhaken, 2 Stück  
D 25 mm / 1"

8 **RB320**  
Spare toilet roll holder  
Reservpappershållare  
Reservpapierholder  
Reserverullholder  
Varapaperteline  
Reservpapierhalter  
H 140 mm / 5 1/2"

3 **RB3464**  
Single towel rail  
Enkel handduksstång  
Enkel håndklædestang  
Enkel håndklestang  
Pyyhetanko  
Handtuchstange  
L 648 mm, cc 600 mm / 25 1/2"

6 **RB359**  
Quadruple hook  
Fyrkrok  
Firekrog  
Kroklíst, 4 kroker  
Nelikkoukusarja  
Viererhakenleiste  
L 178 mm / 7"

9 **RB3411**  
Toilet roll holder  
Toalettpppershållare  
Toiletpapirholder  
Toalettppapirholder  
WC-paperteline  
Toilettenpapierhalter  
L152 mm / 6"

1



4



7



2



5

6



3



8



**1 RX343 \***

Glass tumbler - frosted glass  
Tandborstglas med hållare  
Holder med tandkrus  
Tannglass i frostat glass  
Hammasmukiteline, muki huurrelasia  
Zahnputzbecher

**4 RX342 \***

Soap dish - frosted glass  
Tvålkopp. Frostat glas  
Sæbeskål. Materet glas.  
Såpekopp i frostat glass  
Saippuakupitteline. Kuppi huurrelasia  
Seifenschale

**7 RX370**

Soap dispenser  
Tvåldispenser  
Sæbedispenser  
Såpedispenser  
Saippua-annostelija  
Seifenspender  
H 160 mm / 6 1/4"

**2 RX369 \***

Glass soap dispenser  
Tvåldispenser. Insats av glas  
Sæbedispenser. I materet glas  
Såpedispenser. I frostat glass  
Saippua-annostelija. Pullo huurrelasia  
Seifenspender. Behåller aus Glas  
H 180 mm / 7"

**5 RX333 \***

Toilet brush - frosted glass  
WC-børste. Frostat glas  
WC-børste. Materet glas  
WC-børste i frostat glass  
WC-harja. Kuppi huurrelasia  
WC-Bürste  
H 380 mm / 15"

**8 RX320**

Spare toilet roll holder  
Reservpappershållare  
Reservpapierholder  
Reserverullholder  
Varapaperiteline  
Reservpapierhalter  
H 140 mm / 5 1/2"

**3 RX341**

Toilet roll holder  
Toalettppappershållare  
Toiletppapirholder  
Toalettppapirholder  
WC-paperiteline  
Toilettenpapierhalte

**6 RX332**

Toilet brush  
WC-børste  
WC-børste  
WC-børste  
WC-harja  
WC-Bürste  
H 390 mm / 15 3/8"

\* Porcelain parts are available separately / Porslinsdelar finns att köpa separat / Porcelændele kan købes separat  
Porselensdeler kan kjøpes lost / Posliiniosat ovat saatavilla erikseen / Porzellan-Teile separat erhältlich

1



4



6



2



5



3



**1 RX355**  
Towel hook  
Enkelkrok  
Krog  
Enkelkrok  
Pyyhekoukku  
Handtuchhaken  
45 x 45 mm / 1 7/8" x 1 7/8"

**3 RX3464**  
Single towel rail  
Enkel Handduksstång  
Enkel håndklædestang  
Enkel håndklestang  
Pyyhetanko  
Handtuchstange  
L 648 mm, cc 600 mm / 25 1/2"

**5 RX359**  
Quadruple hook  
Fyrkrok  
Firekrog  
Kroklis, 4 kroker  
Nelikkoukkusarja  
Vierhakenleiste  
L 178 mm / 7"

**2 RX356**  
Double towel hook  
Dubbel badlakanskrok  
Dobbelt krog  
Dobbelt krok  
Kaksoispyyhekoukku  
Doppelter Badetuchhaken  
L 90 mm / 3 1/2"

**4 RX3455**  
Towel hook, pair  
Enkelkrok, par  
Krog, par  
Enkelkrok, par  
Nuppikoukkupari  
Handtuchhaken, 2 Stück  
D 25 mm / 1"

**6 RX344**  
Towel ring  
Handduksring  
Håndklædering  
Håndklæring  
Pyyherengas  
Handtuchring  
Ø 170 mm / 8 3/4"





# ICE



- EN ICE was gently designed with the cold, sophisticated lines, that are typical for modern Scandinavian design.
- SE Badrumsserien ICE skapades med de enkla, vackra linjer som representerar Skandinavisk design.
- DK Badeværelseserien ICE blev skabt med de enkle, smukke linjer, der repræsenterer skandinavisk design.
- NO Baderomsserien ICE ble skapt med de rene vakre linjene som representerer skandinavisk design.
- FI ICE sarja luotiin kylmien muotoilulinjojen mukaan, jotka ovat tyypillisiä modernin Skandinaavisen designin tunnusmerkkejä.
- DE ICE wurde sanft mit den kühlen, eleganten Linien entworfen, die für das moderne skandinavische Design typisch sind.



POLISHED CHROME (OK)

1



4



6



2



3



5



1 **OK470P**  
 Porcelain soap dispenser  
 Tvåldispenser. Behållare av porslin  
 Sæbedispenser. I porcelæn  
 Såpedispenser. Beholder av porselen  
 Saippua-annostelija. Posliini  
 Seifenspender. Behälter aus Porzellan  
 H 180 mm / 7"

4 **OK469P**  
 Porcelain soap dispenser  
 Tvåldispenser. Insats av porslin  
 Sæbedispenser. I porcelæn  
 Såpedispenser. Beholder av porselen  
 Saippua-annostelija. Posliini  
 Seifenspender. Behälter aus Porzellan  
 H 180 mm / 7"

6 **OK433P**  
 Toilet brush with porcelain tumbler  
 WC-børste. Insats av porslin  
 WC-børste. I porcelæn  
 WC-børste. Beholder av porselen  
 WC-Harja. Posliini  
 WC-Bürste. Behälter aus Porzellan  
 H 380 mm / 15"

2 **OK461P**  
 Porcelain soap dispenser  
 Tvåldispenser. Insats av porslin  
 Sæbedispenser. I porcelæn  
 Såpedispenser. Beholder av porselen  
 Saippua-annostelija. Posliini  
 Seifenspender. Behälter aus Porzellan  
 H 115 mm / 4,5"

5 **OK443P**  
 Holder with porcelain tumbler  
 Tandborstglas. Insats av porslin  
 Tandkrus. I porcelæn  
 Tannglass. Beholder av porselen  
 Hammasmukiteline. Muki posliini  
 Zahnputzbecher, Becher aus Porzellan

3 **OK442P**  
 Soap dish - porcelain  
 Tvålkopp. Insats av porslin  
 Sæbeskål. I porcelæn  
 Holder med såpekopp  
 Saippuakupitteline. Posliini  
 Seifenschale aus Porzellan

1



4



6



2



7



3



5



8



**1 OK320**  
Spare toilet roll holder  
Reservpappershållare  
Reservepapirholder  
Reserverullholder  
Varapaperiteline  
Reservepapierhalter  
H 140 mm / 5 1/2"

**4 OK3455**  
Towel hook, pair  
Enkelkrok, par  
Krog, par  
Enkelkrok, par  
Nuppikoukkupari  
Handtuchhaken, 2 Stück  
D 25 mm / 1"

**6 OK358**  
Bath robe hook  
Badrockskrok  
Badekåbe krog  
Krok for badekåbe  
Kylpytakkikoukku  
Bademantelhaken  
H 135 mm / 5 1/3"

**2 OK3411**  
Toilet roll holder  
Toalettppappershållare  
Toiletpapirholder  
Toalettppapirholder  
WC-paperiteline  
Toilettenpapierhalter

**5 OK3414**  
Toilet roll holder with cover  
Toalettppappershållare med lock  
Toiletpapirholder med låg  
Toalettppapirholder med lodd  
WC-paperiteline kannella  
Toilettenpapierhalter mit Deckel

**7 OK344**  
Towel ring  
Handduksring  
Håndklædering  
Håndklæring  
Pyhyerengas  
Handtuchring  
L 200 mm / 8"

**3 OK341**  
Toilet roll holder  
Toalettppappershållare  
Toiletpapirholder  
Toalettppapirholder  
WC-paperiteline  
Toilettenpapierhalter

**8 OK327**  
Swing arm triple hook  
Svängbar trippelkrok  
Svingbar trippelkrog  
Svingbar trippelkrok  
Kääntyvä kolmoiskoukku  
Schwenkbarer Dreierhaken  
L 127 mm / 5"  
H 95 mm / 3 3/4"

1



2



3

1 **OK355**

Towel hook  
Enkelkrok  
Krog  
Enkelkrok  
Pyyhekoukku  
Handtuchhaken

45 x 45 mm / 1 7/8" x 1 7/8"

2 **OK356**

Double towel hook  
Dubbel badlakanskrok  
Dobbelt krog  
Dobbelt krok  
Kaksoispyyhekoukku  
Doppelter Badetuchhaken

L 90 mm / 3 1/2"

3 **OK359**

Quadruple hook  
Fyrkrok  
Firekrog  
Kroklist, 4 kroker  
Nelikkoukku  
Viererhakenleiste

L 178 mm / 7"

4



5

4 **OK369P**

Porcelain soap dispenser  
Tvåldispenser. Insats av porslin  
Sæbedispenser. I porcelæn  
Såpedispenser. Beholder av porselen  
Saippua-annostelija. Posliini  
Seifenspender. Behälter aus Porzellan

H 180 mm / 7"

5 **OK333P**

Toilet brush with porcelain tumbler  
WC-börste. Insats av porslin  
WC-börste. I porcelæn  
WC-börste. Beholder av porselen  
WC-Harja. Posliini  
WC-Bürste. Behälter aus Porzellan

H 380 mm / 15"

6 **OK342P**

Soap dish - porcelain  
Tvålkopp. Insats av porslin  
Sæbeskål. I porcelæn  
Såpekopp i frostet glass  
Saippuakupitteline. Posliini  
Seifenschale aus Porzellan

6



7



8

7 **OK343P**

Holder with porcelain tumbler  
Tandborstglas. Insats av porslin  
Tandkrus. I porcelæn  
Tannglass i porselen  
Hammasmukiteline. Muki posliini  
Zahnputzbecher, Becher aus Porzellan

8 **OK325**

Grab bar  
Badkarshandtag  
Badekarsgreb  
Badekarsåndtak  
Tukikahva  
Wannengriff

L 267 mm / 10 5/8"

1



4



2



6



3



5



**1 OK323**  
Holder for hairdryer and straightener  
Hållare till hårfön och plattång  
Holder for hårtørrer og fladtang  
Holder for hårtørrer og rettetang  
Hiustenkuivaajan pidike  
Fönhalter  
L 129 mm / 5"

**4 OK374**  
Corner soap basket  
Hörntvålkorv  
Hjørne brusekurv  
Dusjkurv for hjørne  
Kulmakori  
Eckseifenkorb  
200 x 200 mm. H 70 mm  
8"W x 2 3/4"H x 8"D

**6 OK347**  
Frosted glass shelf - tempered glass  
Badrumshylla. Hyllan av frostat säkerhetsglas  
Badeværelsesshylde. Hylde i materet glas.  
Baderomshylle. Hylle i frostat glass  
Kylpyhuonehylly. Hylly huurrelasia  
Badezimmerkonsole Sicherheitsglas matt  
L 600 mm / 24"

**2 OK326**  
Swing arm towel rail  
Svängbar handduksstång  
Svingbar håndklædestang  
Svingbar håndklestang  
Kääntövä kaksoispyyhetanko  
Schwenkbare Handtuchstange  
L 440 mm / 17 1/2"

**5 OK3464**  
Single towel rail  
Enkel handduksstång  
Enkel håndklædestang  
Enkel håndklestang  
Enkel håndklestang  
Pyyhetanko  
Handtuchstange  
L 645 mm / 24 4/5"

**3 OK3465**  
Single towel rail  
Enkel handduksstång  
Enkel håndklædestang  
Enkel håndklestang  
Pyyhetanko  
Handtuchstange  
L 845 mm / 33 1/4"

# LIVING



- EN LIVING are elegant bath and shower grab bars designed to enhance the safety of your bathroom.
- SE LIVING är bad- och duschhandtag i elegant design och med fokus på säkerhet.
- DK LIVING er et bad og brusehåndtag i elegant design med fokus på sikkerhed.
- NO LIVING er bade- og dusjhåndtak i elegant design med fokus på sikkerhet.
- FI LIVING on suunniteltu tarjoamaan eleganttia turvallisuutta kylpyhuoneeseesi.
- DE LIVING sind elegante Halte- und Wandgriffe für Bad und Dusche, die die Sicherheit Ihres Badezimmers erhöhen.

! Load Max 150 kg.



STAINLESS STEEL POLISHED (FK)



**1 FK806**  
 Grab bar curved short  
 Badkarshandtag svängd modell kort  
 Badekarsgreb buet model, kort  
 Badekarhåndtak buet modell, kort  
 Tukikahva taivutettu lyhyt malli  
 Wannengriff kurze gebogene Version  
 L 300 mm / 12" Ø 25 mm / 1"

**2 FK807**  
 Grab bar curved long  
 Badkarshandtag svängd modell lång  
 Badekarsgreb buet model, lang  
 Badekarhåndtak buet modell, lang  
 Tukikahva taivutettu pitkä malli  
 Wannengriff lange gebogene Version  
 L 600 mm / 24" Ø 25 mm / 1"

**3 FK808**  
 Grab bar curved long v-form 135°  
 Badkarshandtag svängd modell lång v-form 135°  
 Badekarsgreb buet model, lang v-form 135°  
 Badekarhåndtak buet modell, lang v-form 135°  
 Tukikahva taivutettu pitkä V-muoto 135°  
 Wannengriff lange gebogene Version v-form/ 135°  
 L 500 mm / 19 1/2" Ø 25 mm / 1"

**4 FK404**  
 Folding wall mounted shower seat, white  
 Fällbar vägghängd duschsits, vit  
 Vægghængt klappsæde, hvid  
 Vegghengt klappsete, hvit  
 Taittuva seinään asennettava suihkuistuin,  
 valkoinen  
 Duschklappsitz wandmontiert, weiß

**5 FK414**  
 Folding wall mounted shower seat, grey  
 Fällbar vägghängd duschsits, grå  
 Vægghængt klappsæde, mørk grå  
 Vegghengt klappsete, mørk grå  
 Taittuva seinään asennettava suihkuistuin,  
 harmaa  
 Duschklappsitz wandmontiert, grau

**6 FK840**  
 Hinged grab bar  
 Uppfällbart stödhandtag  
 Sammenklappelig støttehandtag  
 Innfellbart støttehåndtak  
 Taivutettava tukikahva  
 Stütz-Klappgriff  
 L 700 mm / 27.5"

**7 FK406**  
 Shower stool, white polypropylene  
 Badrumspall, vit  
 Badeværelsetaburet, hvid  
 Baderomskrakk, hvit  
 Kylpyhuonejakkara, valkoinen  
 Duschhocker, weiß  
 H 480 mm / 19"

**8 FK416**  
 Shower stool, grey polypropylene  
 Badrumspall, grå  
 Badeværelsetaburet, mørk grå  
 Baderomskrakk, mørk grå  
 Kylpyhuonejakkara, harmaa  
 Duschhocker, grau  
 H 480 mm / 19"

**! Load Max 150 kg.**



**1 FK810**  
 Single grab bar  
 Badkarshandtag  
 Badekarsgreb  
 Badekarhåndtak  
 Tukikahva  
 Haltegriff  
 L 400 mm / 15 3/4"  
 Ø 32 mm / 13/8"

**2 FK811**  
 Double grab bar  
 Dubbelt badkarshandtag  
 Dobbelt badekarsgreb  
 Badekarhåndtak  
 Kaksoistukikahva  
 Haltegriff  
 L 900 mm / 35 7/16"  
 Ø 32 mm / 13/8"

**3 FK812**  
 V-shaped grab bar, left  
 V-format badkarshandtag, vänster  
 V-format badekarsgreb, venstre  
 V-format badekarhåndtak, venstre  
 V-muotoinen tukikahva, vasen  
 V-förmiger Haltegriff, links  
 L 400 mm / 15 3/4"  
 Ø 32 mm / 13/8"

**4 FK813**  
 V-shaped grab bar, right  
 V-format badkarshandtag, höger  
 V-format badekarsgreb, højre  
 V-format badekarhåndtak, høyre  
 V-muotoinen tukikahva, oikea  
 V-förmiger Haltegriff, rechts  
 L 400 mm / 15 3/4"  
 Ø 32 mm / 13/8"

**5 FK815**  
 Corner grab bar  
 Badkarhandtag för hörn  
 Badekarhåndtak til hjørne  
 Badekarhåndtak for hjørne  
 Tukikahva kulmamalli  
 Haltegriff-Winkelset  
 L 730 mm / 28 47/64"  
 Ø 32 mm / 13/8"

**6 FK814**  
 L-shaped shower bar, left  
 L-format duschhandtag, vänster  
 L-format brusebadhåndtag, venstre  
 L-format dusjstang, venstre  
 L-muotoinen tukikahva, vasen  
 Brausestange links-Verlängerung  
 L 530 mm / 20 55/64"  
 Ø 32 mm / 13/8"

**7 FK816**  
 L-shaped shower bar, right  
 L-format duschhandtag, höger  
 L-format brusebadhåndtag, højre  
 L-format dusjstang, høyre  
 L-muotoinen tukikahva, oikea  
 Brausestange rechts-Verlängerung  
 L 530 mm / 20 55/64"  
 Ø 32 mm / 13/8"

**8 FK817**  
 Shower bar, T-connection  
 Duschhandtag, T-kopping  
 Brusebadhåndtag, T-form  
 Dusjstang, T-form  
 T-muotoinen tukikahva  
 Vertikale Brausestange  
 H 1160 mm / 4"  
 Ø 32 mm / 13/8"

! Load Max 150 kg.



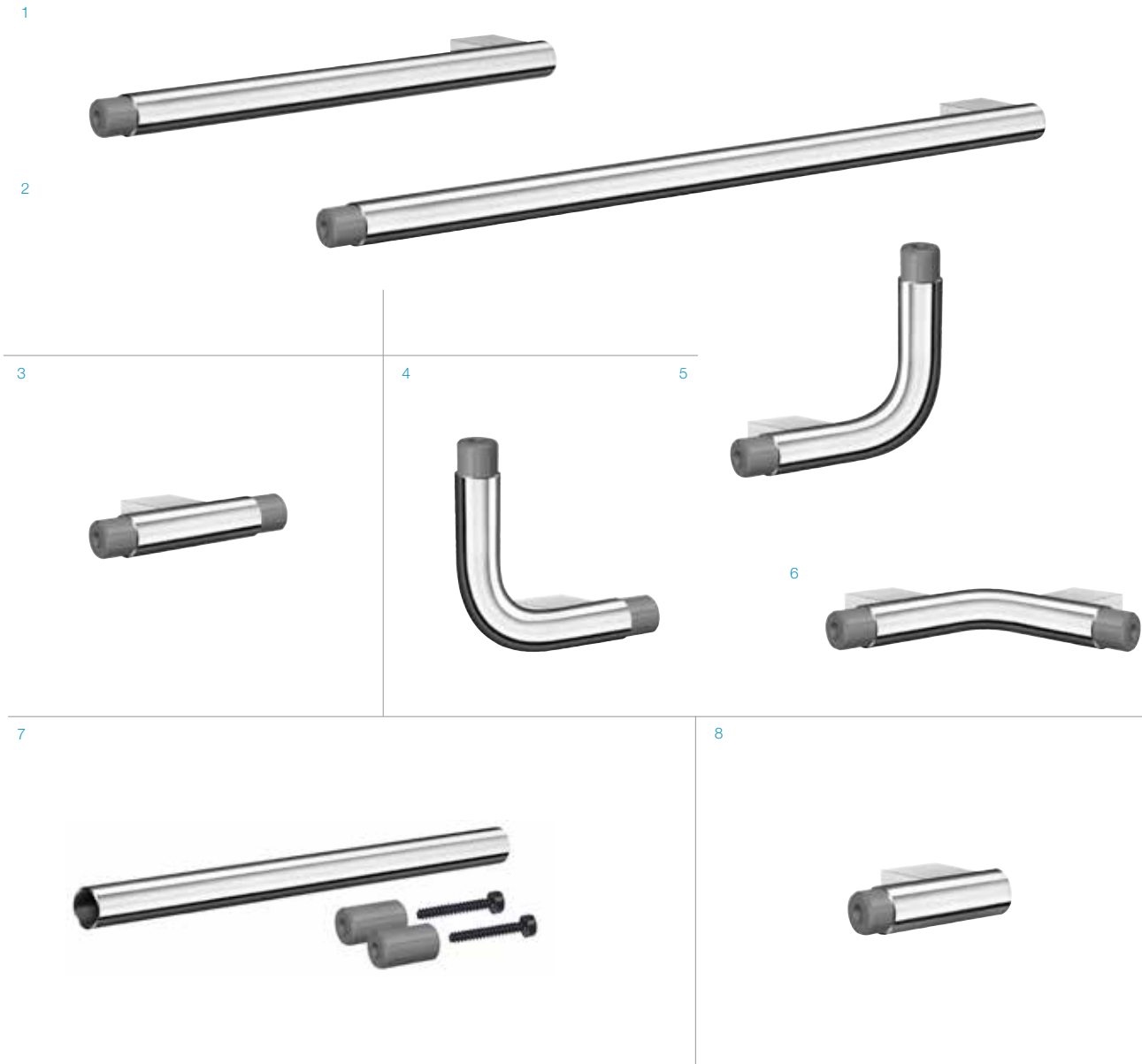

**1 FK820**  
Fixing point  
Fixeringspunkt  
Fixing point  
Monteringspunkt  
Tukikahva  
Verlängerung 400 mm

L 400 mm / 15 3/4"  
Ø 32 mm / 13/8"

**2 FK821**  
Fixing point  
Fixeringspunkt  
Fixing point  
Monteringspunkt  
Tukikahva  
Verlängerung 600 mm

L 600 mm / 23 5/8"  
Ø 32 mm / 13/8"

**3 FK830**  
Connection T-shape  
Anslutning T-form  
Forbindelse T-form  
Mellomstykke T-form  
T-muotoinen liitäntä  
T-Anschlusstück

L 100 mm / 3 15/16"  
Ø 32 mm / 13/8"

**4 FK831**  
Connection L-shape, right  
L-formad kopplingsdel, höger  
Koblingsdel L-form, højre  
Kobling L-form, høyre  
Asennuspiste kulmaan, oikea  
Verbindungelement L Form, rechts

L 130 mm / 5/8"  
Ø 32 mm / 13/8"

**5 FK833**  
Connection L-shape, left  
L-formad kopplingsdel, vänster  
Koblingsdel L-form, venstre  
Kobling L-form, venstre  
Asennuspiste kulmaan, vasen  
Verbindungelement L Form, links

L 130 mm / 5/8"  
Ø 32 mm / 13/8"

**6 FK832**  
Corner connection  
Kopplingsdel för hörn  
Koblingsdel for hjørne  
Hjørne kobling  
Asennuspiste kulmaan  
Eckverbindung 90 grad

L 130 mm / 5/8"  
Ø 32 mm / 13/8"

**7 FK835**  
Connection bar  
Rak kopplingsdel  
Lige koblingsdel  
Kobling, rett  
Asennuspiste suora  
Erweiterungselement

L 400 mm / 15 3/4"  
Ø 32 mm / 13/8"

**8 FK834**  
Fixing point  
Fixeringspunkt  
Fixing point  
Monteringspunkt  
Tukikahva  
Verlängerung 100 mm

L 100 mm / 3 15/16"  
Ø 32 mm / 13/8"

! Load Max 150 kg.



1



2



4

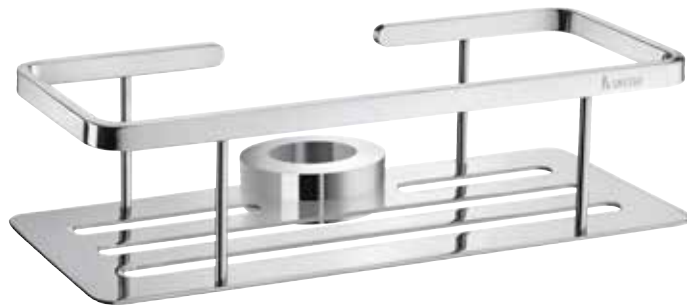

3

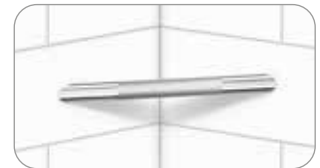

5

**1 FK850 \***

Bathroom shelf for Grab bar  
Hylla för badkarshandtag  
Hylde til badekarsgreb  
Hylle til badekarhåndtak  
Sarjan kanssa yhteensopiva hylly  
Ablage für LIVING Haltegriffsystem

L 365 mm / 14.25"  
D 58 mm / 2.25"

**2 FK851**

Hook for Grab bar  
Krok för badkarshandtag  
Krog til badekarsgreb  
Krok til badekarhåndtak  
Koukku  
Haken für LIVING Haltegriffsystem

H 82 mm / 3.25"  
Ø 32 mm / 13/8"

**3 FK855**

Toilet Roll holder for Grab bar  
Toalettpappershållare  
Toiletpapirholder til badekarsgreb  
Toalettpapirholder til badekarhåndtak  
WC-paperiteline  
Toilettenpapierhalter für LIVING

**4 FK856**

Basket for Shower riser rail  
Duschkorg för LIVING stång  
Kurv til LIVING brusestang  
Kurv til LIVING dusjstang  
Sarjan kanssa yhteensopiva suihkukori  
Duschkorb für die Brausestange

250 x 103 / 10" x 4"  
Ø 32 mm / 13/8"

**5 FK841**

Footrest, corner  
Fotstöd, hörn  
Fodstøtte, hjørne  
Fotstøtte, hjørne  
Jalkatuki, kulmamalli  
Fußstütze, ecke

L 293 mm / 11 1/2"  
Ø 24 mm / 15/16"

\* FK850 is compatible with FK811 and in combination with FK834+FK820, (FK817+FK821+FK834).  
FK850 är kompatibel med FK811 samt kombinationer med FK834+FK820, (FK817+FK821+FK834).  
FK850 er kompatibel med FK811 samt kombinationer med FK834+FK820, (FK817+FK821+FK834).  
FK850 er kompatibel med FK811 samt kombinasjoner med FK834+FK820, (FK817+FK821+FK834).  
FK850 on yhteensopiva FK811:n sekä FK834+FK820:n (FK817+FK821+FK834) kanssa.  
FK850 ist kompatibel mit FK811 sowie Kombinationen mit FK834+FK820, (FK817+FK821+FK834).



# OUTLINE



- EN In the OUTLINE series you'll find elegant free standing accessories in both round and square design, the perfect accompaniment to our other smedbo ranges.
- SE OUTLINE är en serie eleganta fristående badrumstillbehör av både kantig och rundad design som går utmärkt att kombinera med Smedbos övriga produkter.
- DK OUTLINE er en serie af elegant fritstående badeværelsestilbehør i både kantet og afrundet design, som er fremragende at kombinere med Smedbos andre produkter.
- NO OUTLINE er en serie av elegante baderomsprodukter i både kantet og rund design som kan kombineres med Smedbos øvrige sortiment.
- FI OUTLINE sarjasta löydät elegantteja vapaasti seisovia tarvikkeita. Saatavilla on sekä kantikkaita että pyöreällä designilla olevia vaihtoehtoja.
- DE In der OUTLINE-Serie finden Sie elegante Standaccessoires in runder und quadratischer Ausführung, die perfekt zu unseren anderen Smedbo-Serien passen.



BLACK (FB)  
POLISHED CHROME (FK)

1



4



5



2



3



6



**1 FK442**  
 Make-up mirror. Self-adhesive/magnetic. Magnification X5  
 Sminkspegel. Självhäftande/magnetisk. Förstoring X5  
 Selvklæbende magnetisk Sminkespejl. Forstørrelse X5  
 Sminkespeil. Selvklebende/magnetisk. Förstørrelse X5  
 Meikkipeili. Tarrakiinitys/magneettinen. 5X suurennus  
 Kosmetikspiegel. Selbstklebend/magnetisch. Vergrößerung X5  
 Ø 152 mm / 6"

**2 FK443**  
 Travel mirror. With swivel stand. Magnification X1/X5  
 Sminkspegel med stödben. Förstoring X1/X5  
 Rejsespejl med foldefod. Forstørrelse X1/X5  
 Sminkespeil. Forstørrelse X1/X5  
 Tukijalallinen matkapeli. X1/5X suurennus  
 Kosmetikspiegel. Mit schenkbarem Stellfuss. Vergrößerung X1/X5  
 Ø 152 mm / 6"

**3 FK445**  
 Make-up mirror. Magnification X1/X7  
 Sminkspegel. Förstoring X1/X7  
 Sminkespejl. Forstørrelse X1/X7  
 Sminkespeil. Forstørrelse X1/X7  
 Meikkipeili. X1/X7 suurennus  
 Kosmetikspiegel. Vergrößerungen X1/X7  
 Ø 200 mm / 7 7/8". L 340 mm / 13 3/8"

**4 FK490**  
 Make-up mirror. Magnification X1/X7  
 Sminkspegel. Förstoring X1/X7  
 Sminkespejl. Forstørrelse X1/X7  
 Sminkespeil. Forstørrelse X1/X7  
 Meikkipeili. X1/X7 suurennus  
 Kosmetikspiegel. Vergrößerungen X1/X7  
 Ø 200 mm / 7 7/8". L 170 mm / 6 3/4"

**5 FK435**  
 Make-up mirror. Magnification X1/X3  
 Sminkspegel. Förstoring X1/X3  
 Sminkespejl. Forstørrelse X1/X3  
 Sminkespeil. Forstørrelse X1/X3  
 Meikkipeili. X1/X3 suurennus  
 Kosmetikspiegel. Vergrößerung X1/X3  
 Ø 200 mm / 7 7/8" H 375 mm / 14 3/4"

**6 FB438 / FK438**  
 Make-up mirror. Magnification X1/X5  
 Sminkspegel. Förstoring X1/X5  
 Sminkespejl. Forstørrelse X1/X5  
 Sminkespeil. Forstørrelse X1/X5  
 Meikkipeili. X1/X5 suurennus  
 Kosmetikspiegel. Vergrößerungen X1/X5  
 Ø 200 mm / 7 7/8". L 340 mm / 13 3/8"

1



4



2



3



5



6



1 **FK485EBP** (LED/Dual light)  
Shaving/Make-up Mirror. Magnification X5  
Rak-/sminkspegel. Förstoring X5  
Barber-/sminkespejl. Forstørrelse X5  
Barber-/sminkespeil. Forstørrelse X5  
Meikkipeili. 5X suurennus  
Rasier-/Kosmetikspeigel. Vergrößerung X5  
Ø 200 mm / 7 7/8". L 340 mm / 13 3/8"

2 **FK474E** (LED/Dual light)  
Shaving/Make-up Mirror. Magnification X5  
Rak-/sminkspegel. Förstoring X5  
Barber-/sminkespejl. Forstørrelse X5  
Barber-/sminkespeil. Forstørrelse X5  
Meikkipeili. X1/X5 suurennus  
Rasier-/Kosmetikspeigel. Vergrößerung X5  
Ø 180 mm / 7". H 350 mm / 13 5/8"

3 **FK484EP** (LED/Dual light)  
Shaving/Make-up Mirror. Magnification X5  
Rak-/sminkspegel. Förstoring X5  
Barber-/sminkespejl. Forstørrelse X5  
Barber-/sminkespeil. Forstørrelse X5  
Meikkipeili. 5X suurennus  
Rasier-/Kosmetikspeigel. Vergrößerung X5  
Ø 200 mm / 7 7/8". H 380 mm / 15"

4 **FK485EP** (LED/Dual light)  
Shaving/Make-up Mirror. Magnification X5  
Rak-/sminkspegel. Förstoring X5  
Barber-/sminkespejl. Forstørrelse X5  
Barber-/sminkespeil. Forstørrelse X5  
Meikkipeili. 5X suurennus  
Rasier-/Kosmetikspeigel. Vergrößerung X5  
Ø 200 mm / 7 7/8". L 340 mm / 13 3/8"

5 **FK484EBP** (LED/Dual light)  
Shaving/Make-up Mirror. Magnification X5  
Rak-/sminkspegel. Förstoring X5  
Barber-/sminkespejl. Forstørrelse X5  
Barber-/sminkespeil. Forstørrelse X5  
Meikkipeili. 5X suurennus  
Rasier-/Kosmetikspeigel. Vergrößerung X5  
Ø 200 mm / 7 7/8". H 380 mm / 15"

6 **FK484EWP** (LED/Dual light)  
Shaving/Make-up Mirror. Magnification X5  
Rak-/sminkspegel. Förstoring X5  
Barber-/sminkespejl. Forstørrelse X5  
Barber-/sminkespeil. Forstørrelse X5  
Meikkipeili. 5X suurennus  
Rasier-/Kosmetikspeigel. Vergrößerung X5  
Ø 200 mm / 7 7/8". H 380 mm / 15"



Battery operated (batteries not included) / Batteridrevet (batterier ingår ej) / Drives med batterier (medfølger ikke)  
Batteridrevet (batterier ikke inkludert) / Paristokäyttöinen (paristot eivät sisälly toimitukseen) / Batteriebetrieb (Batterien nicht im Lieferumfang)

1



2



3



4



**1 FK486EP (LED/Dual light)**  
Shaving/Make-up Mirror. Magnification X7  
Rak-/sminkspegel. Förstoring X7  
Barber-/sminkespejl. Forstørrelse X7  
Barber-/sminkespeil. Forstørrelse X7  
Meikkipeili. 7X suurennus  
Rasier-/Kosmetikspiegel. Vergrößerung X7  
Ø 200 mm / 7 7/8". L 340 mm / 13 3/8"

**2 FK486H (LED/Dual light)**  
Shaving/Make-up Mirror. Magnification X7  
Rak-/sminkspegel. Förstoring X7  
Barber-/sminkespejl. Forstørrelse X7  
Barber-/sminkespeil. Forstørrelse X7  
Meikkipeili. 7X suurennus  
Rasier-/Kosmetikspiegel. Vergrößerung X7  
Ø 200 mm / 7 7/8". L 340 mm / 13 3/8"

**3 FK487H (LED)**  
Shaving/Make-up Mirror. Magnification X7  
Rak-/sminkspegel. Förstoring X7  
Barber-/sminkespejl. Forstørrelse X7  
Barber-/sminkespeil. Forstørrelse X7  
Meikkipeili. 7X suurennus  
Rasier-/Kosmetikspiegel. Vergrößerung X7  
Ø 215 mm / 8 7/16". H 380 mm / 14 15/16"

**4 FK483EP (LED/Dual light)**  
Shaving/Make-up Mirror. Magnification X5  
Rak-/sminkspegel. Förstoring X5  
Barber-/sminkespejl. Forstørrelse X5  
Barber-/sminkespeil. Forstørrelse X5  
Meikkipeili. 5X suurennus  
Rasier-/Kosmetikspiegel. Vergrößerungen X5  
200 x 200 mm / 7 7/8" x 7 7/8" L 340 mm / 13 3/8"



Plug directly into the wall socket / Ansluts direkt i vägguttaget / Tilslutes direkte til en stikkontakt  
Koble direkte til en veggkontakt / Pistotulpallinen, kytketään pistorasiaan  
Einfach direkt in die Steckdose stecken



### Hardwiring

Inbyggd elanslutning, utan synlig sladd. Fackman krävs för installation / Built-in electrical connection, without visible cord. Professionals are required for installation.  
For indbygget elektrisk forbindelse. Må kun udføres af en kvalificeret elektriker / For fast montering. Må kun udføres av en kvalifisert elektriker.  
Sisäänrakennettu sähköliitin (ei näkyvää virtajohtoa). Ammattilainen tarvitaan asennukseen  
Direktanschluss ohne sichtbares Kabel. Elektroarbeiten nur vom qualifizierten Fachmann.



1



3



2



5



5

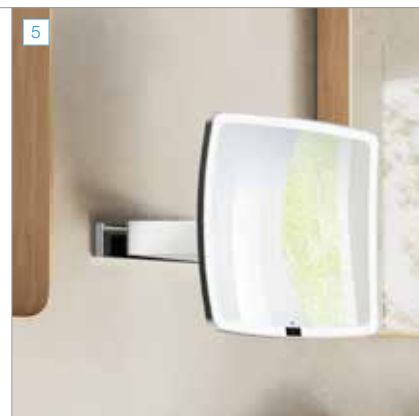

**1 FK488EP (LED)**  
 Shaving/Make-up Mirror. Magnification X7  
 Rak-/sminkspegel. Förstoring X7  
 Barber-/sminkespejl. Forstørrelse X7  
 Barber-/sminkespeil. Forstørrelse X7  
 Meikkipeili. 7X suurennus  
 Rasier-/Kosmetikspiegel. Vergrößerung X7  
 Ø 215 mm / 8 7/16". H 380 mm / 14 15/16"

**2 FK487EP (LED)**  
 Make-up mirror. Magnification X7  
 Sminkspegel. Förstoring X7  
 Sminkespejl. Forstørrelse X7  
 Sminkespeil. Forstørrelse X7  
 Meikkipeili. 7X suurennus  
 Kosmetikspiegel. Vergrößerung X7  
 Ø 215 mm / 8 7/16". L 340 mm / 13 3/8"

**3 FK491EP (LED)**  
 Shaving/Make-up Mirror. Magnification X7  
 Rak-/sminkspegel. Förstoring X7  
 Barber-/sminkespejl. Forstørrelse X7  
 Barber-/sminkespeil. Forstørrelse X7  
 Meikkipeili. 7X suurennus  
 Rasier-/Kosmetikspiegel. Vergrößerung X7  
 Ø 200 mm / 7 7/8". L 380 mm / 14 15/16"

**4 FB444 (Black) / FK444 (Chrome) (LED)**  
 Make-up mirror. Magnification X1/X7  
 Sminkspegel. Förstoring X1/X7  
 Sminkespejl. Forstørrelse X1/X7  
 Sminkespeil. Forstørrelse X1/X7  
 Meikkipeili. X1/X7 suurennus  
 Kosmetikspiegel. Vergrößerung X1/X7  
 Ø 180 mm / 7"

**5 FK492EP (LED)**  
 Make-up mirror. Magnification X7  
 Sminkspegel. Förstoring X7  
 Sminkespejl. Forstørrelse X7  
 Sminkespeil. Forstørrelse X7  
 Meikkipeili. 7X suurennus  
 Kosmetikspiegel. Vergrößerung X7  
 200 x 200 mm / 7 7/8" x 7 7/8"  
 L 380 mm / 14 15/16"



Rechargeable battery, charge with USB / Batteridrevet med batteri laddningsbart via USB / Drevet med genopladeligt batteri, oplades via USB  
 Ladattava akku, lataus USB:llä / Batteridrevet Oppladbar, lades via USB / Akkubetrieben, der über USB aufgeladen werden kann



**1 FK312P \***  
Toilet brush/roll holder - Free standing.  
Fristående toalettpappershållare/ WC-borste.  
Frittstående toalettpapirholder/WC-borste.  
Frittstående toalettpapirholder/WC-borste  
Vapaasti seisova WC-paperiteline/ WC-harja.  
WC-Standmodell mit Toilettenpapierhalter.

H 780 mm / 30 11/16". Ø 230 mm / 9 1/16"

**FK312** - Glass, glas, glas, glass, lasi, Glas

**2 FK315**  
Swing arm towel rail - Free standing  
Fristående svängbar handduksstång  
Svingbar handklädestang. Frittstående.  
Svingbar handklädestang. Frittstående  
Kääntyvä pyyhetanko. Vapaasti seisova  
Schwenkbare Handtuchstange. Standmodell

H 870 mm / 34 1/4". Ø 230 mm / 9 1/16"

**3 FK313**  
Toilet roll holder - Free standing. Round  
Fristående reservpappershållare rund  
Frittstående reservepapirholder. Rund  
Frittstående reservrollholder. Rund  
Vapaasti seisova WC-paperiteline. Pyöreä  
Toilettenpapierhalter, rund

H 394 mm / 15 1/2". Ø 230 mm / 9 1/16"

**4 FK311P**  
Toilet brush. Free standing - porcelain  
Fristående WC-borste. Insats av porslin  
WC-borste. Frittstående. Beholder i porcelæn.  
WC-borste. Frittstående. Beholder i porcelæn.  
WC-harja.Vapaasti seisova. Posliini  
WC-Bürste. Standmodell

H 415 mm / 16 5/16"

**FK311** - Glass, glas, glas, glass, lasi, Glas

**5 FK321P**  
Toilet brush. Free standing - porcelain  
Fristående WC-borste. Insats av porslin  
WC-borste. Frittstående. Beholder i porcelæn.  
WC-borste. Frittstående. Beholder i porcelæn.  
WC-harja.Vapaasti seisova. Posliini  
WC-Bürste. Standmodell

H 415 mm / 16 5/16"

**6 FK322P \***  
Toilet brush/roll holder - Free standing.  
Fristående toalettpappershållare/ WC-borste.  
Frittstående toalettpapirholder/WC-borste.  
Frittstående toalettpapirholder/WC-borste  
Vapaasti seisova WC-paperiteline/ WC-harja.  
WC-Standmodell mit Toilettenpapierhalter.

H 780 mm / 30 11/16". 230 x 230 mm / 9 1/16"

**7 FK325**  
Swing arm towel rail - Free standing  
Fristående svängbar handduksstång  
Svingbar handklädestang. Frittstående.  
Svingbar handklädestang. Frittstående.  
Kääntyvä pyyhetanko. Vapaasti seisova  
Schwenkbare Handtuchstange. Standmodell

H 870 mm / 34 1/4". 230 x 230 mm / 9 1/16"

**8 FK323**  
Toilet roll holder - Free standing. Square  
Fristående reservpappershållare. Kvadratisk  
Frittstående reservepapirholder. Kvadratisk  
Frittstående reservrollholder. Kvadratisk  
Vapaasti seisova Varapaperiteline neliömäinen  
Toilettenpapierhalter, quadratisch

H 394 mm / 15 1/2". 230 x 230 mm / 9 1/16"

1



**1 FK258**  
 Soap dispenser with 2 containers  
 Tvåldispenser med 2 behållare  
 Sæbedispenser. 2 beholdere  
 Såpedispenser. 2 beholdere  
 Saippua-annostelija kahdella säiliöllä  
 2- fach Seifenspender

112 x 60 mm. H 210 mm  
 4 1/2"W x 8"H x 2 3/8"D

**2 FK257**  
 Soap dispenser with 1 container  
 Tvåldispenser med 1 behållare  
 Sæbedispenser. 1 beholder  
 Såpedispenser. 1 beholder  
 Saippua-annostelija yhdellä säiliöllä  
 1- fach Seifenspender

60 x 60 mm. H 210 mm  
 2 1/4"W x 8"H x 2 3/8"D

2



3



4



**3 FK254**  
 Soap dispenser. Free standing  
 Tvåldispenser. Fristående  
 Sæbedispenser. Fristående  
 Såpedispenser. Frittstående  
 Saippua-annostelija. Vapaasti seisova  
 Seifenspender. Standmodell

H 190 mm / 7 8/16"

**4 FK261**  
 Soap dispenser  
 Tvåldispenser  
 Sæbedispenser.  
 Såpedispenser.  
 Saippua-annostelija  
 Seifenspender

H 167 mm / 6 1/2"

5



6



**5 FK103**  
 Toilet brush. Free standing  
 WC-børste. Fristående  
 WC-børste. Fristående  
 WC-børste. Frittstående  
 WC-harja. Vapaasti seisova  
 WC-Bürste. Standmodell

H 410 mm / 16"

**6 FK259**  
 Soap dispenser with 3 containers  
 Tvåldispenser med 3 behållare  
 Sæbedispenser. 3 beholdere  
 Såpedispenser. 3 beholdere  
 Saippua-annostelija kolmella säiliöllä  
 3- fach Seifenspender

167 x 60 mm. H 210 mm  
 6 1/2"W x 8"H x 2 3/8"D



1



2



3



4



5



6



**1 FK480**

Retractable clothes line  
 Utdragbar klædeslina  
 Udtræksbar tørresnor  
 Uttrekkbar klesnor  
 Ulosvedettävä pyykkinaru  
 Aufrollbare Wäscheleine  
 90 mm / 3 1/2" 2,5 m / 100"

**2 FB210 (Black) / FK210 (Chrome)**

Cabinet towel bar  
 Handduksstång för tvättställsskåp  
 Håndklædestang for kommode  
 Håndkleholder for skap  
 Pyyhetanko. Kiinnitys kaappiin.  
 Handtuchhalter zur Schrankbefestigung  
 L 350 mm / 13 12/16"

**3 FK309**

Towel rail - Free standing  
 Fristående handduksstång  
 Fritstående håndklædestang  
 Frittstående håndklestang  
 Vapaasti seisovat pyyhetanko  
 Handtuchhalter, freistehend  
 H 890 mm / 35"

**4 FK300**

Guest towel rail/Towel rail  
 Gästhanddukhållare/Handduksstång  
 Håndklædestang/Gæstehåndklædestang  
 Håndklestang/Gjestehåndklestang  
 Vieraspyyhkeen pidike/Pyyhetanko  
 Gästehandtuchhalter/Handtuchhalter  
 L 400 mm / 16"

**5 FB211 (Black) / FK211 (Chrome)**

Towel rail  
 Handduksstång  
 Håndklædestang  
 Håndklestang  
 Pyyhetanko  
 Handtuchhalter  
 L 380 mm / 15"

**6 FB212 (Black) / FK212 (Chrome)**

Double Towel rail  
 Dubbel handduksstång  
 Dobbelt håndklædestang  
 Dobbelt håndklestang  
 Kaksoispyyhetanko  
 Doppelte Handtuchstange  
 L 380 mm / 15"



1



3



5



2

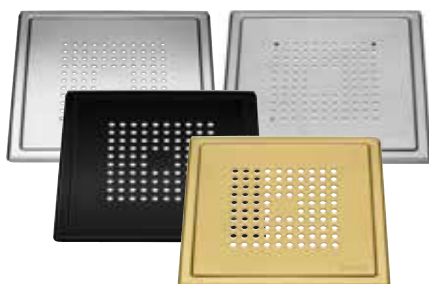

4



6



## 1 FK500/FS500

Floor Grating. Pattern: Star  
Golvbrunnslil i rostfritt stål. Mönster: Stjärna  
Rist til gulvafløb. Mønster: Stjerne  
Slukrist i rustfritt stål. Mönster: Stjerne  
Lattiakaivonkansi ruostumaton teräs. Kuvio; Tähti  
Ablaufsieb. Muster: Sternförmig

200 x 200 mm, H 5,5 mm

## 3 FK504/FS504

Floor Grating. Pattern: Crown  
Golvbrunnslil i rostfritt stål. Mönster: krona  
Rist til gulvafløb. Mönster: Krone  
Slukrist i rustfritt stål. Mönster: Krone  
Lattiakaivonkansi ruostumaton teräs. Kuvio; Liekki  
Ablaufsieb. Muster: Krone

200 x 200 mm, H 5,5 mm

## 5 FK503/FS503

Floor Grating. Pattern: Square for tub  
Golvbrunnslil i rostfritt stål. Mönster: kvadratisk för badkar  
Rist til gulvafløb. Mönster: firkantet til badekar  
Slukrist i rustfritt stål. Mönster: Kvadratisk for badekar  
Lattiakaivonkansi ruostumaton teräs. Kuvio; Neliö.  
Aukko poistoputkelle  
Ablaufsieb/mit Ausschnitt für Ablaufschlauch.  
Muster: Quadratisch

200 x 200 mm, H 5,5 mm

## 2 FB502/FK502/FS502/FV502S

Floor Grating. Pattern: Square  
Golvbrunnslil i rostfritt stål. Mönster: kvadratisk  
Rist til gulvafløb. Mönster: firkantet  
Slukrist i rustfritt stål. Mönster: Kvadratisk  
Lattiakaivonkansi ruostumaton teräs. Kuvio; Neliö  
Ablaufsieb. Muster: Quadratisch

200 x 200 mm, H 5,5 mm

## 4 FB506/FK506/FS506/FV506

Floor Grating. Pattern: Lines  
Golvbrunnslil i rostfritt stål. Mönster: linjer  
Rist til gulvafløb. Mönster: Linjer  
Slukrist i rustfritt stål. Mönster: Linje  
Lattiakaivonkansi ruostumaton teräs. Kuvio; Janat  
Ablaufsieb. Muster: Linien

200 x 200 mm, H 5,5 mm

## 6 FS507

Floor Grating. Pattern: Triangle  
Golvbrunnslil i rostfritt stål. Mönster: Triangel  
Rist til gulvafløb. Mönster: Trekant  
Slukrist i rustfritt stål. Mönster: Triangel  
Lattiakaivonkansi ruostumaton teräs. Kuvio; Kalmio  
Ablaufsieb. Muster: Dreieck

200 x 200 mm, H 5,5 mm

POLISHED (FK) / BRUSHED (FS) / POLISHED BRASS (FV) / BLACK (FB) / BRUSHED BRASS (FV-S)

\* RISTER TIL GULVAFLØB ER IKKE TIL SALG I DANMARK



# OUTLINE LITE



- EN OUTLINE LITE offers a range of free standing accessories with a minimalistic design customed to match our other Smedbo series.
- SE OUTLINE LITE erbjuder en rad fristående badrumstillbehör med minimalistisk design som passar till våra övriga Smedbo serier.
- DK OUTLINE LITE tilbyder en række fristående badeværelsestilbehør med minimalistisk design, der passer til vores andre Smedbo-serie.
- NO OUTLINE LITE tilbyr en rekke med frittstående baderomstilbehør i minimalistisk design som passer til våre øvrige Smedbo produkter.
- FI OUTLINE LITE tarjoaa valikoiman vapaasti seisovia tarvikkeita, joiden minimalistinen design sopii hyvin muiden sarjojen tueksi.
- DE OUTLINE LITE bietet eine Auswahl an freistehenden Accessoires mit einem minimalistischen Design, das speziell auf unsere anderen Smedbo-Serien abgestimmt ist.



STAINLESS STEEL POLISHED (FK)  
STAINLESS STEEL BRUSHED (FS)  
BLACK (FB)  
WHITE (FX)

1



2

**1 FK602**

Toilet roll holder - Free standing  
Fristående toalettpappershållare  
Fristående toalettpapirholder  
Frittstående toalettpapirholder  
Vapaasti seisova WC-paperiteline  
Toilettenpapierhalter

H 600 mm / 24"

**2 FK603**

Toilet brush/roll holder - Free standing  
Fristående toalettpappershållare/ WC-börste  
Fristående toalettpapirholder/WC-börste  
Frittstående toalettpapirholder/WC-börste  
Vapaasti seisova WC-paperiteline/ WC-harja  
WC-Standmodell mit Toilettenpapierhalter

H 600 mm / 24"

3

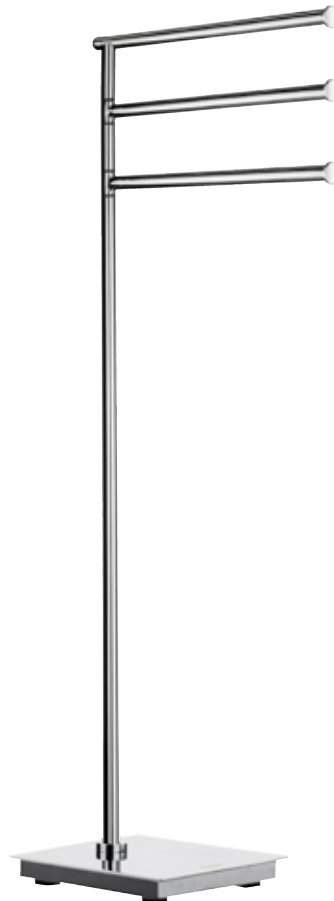

**3 FK604**

Triple swing arm towel rail - Free standing  
Fristående svängbar 3-armad handduksstång  
Svingbar 3-armet handklædestand  
Svingbar 3-armed håndklestang  
Vapaasti seisova 3-osainen kääntyvä pyyhetanko  
Badetuchhalter Standmodell. 3-armig

H 780 mm / 31"

**4 FK636**

Toilet/Spare roll holder, free standing  
Toalett/Reservpappershållare, fristående  
Toilet/Reservpapirholder, fristående  
Toalett/Reservpapirholder, frittstående  
WC-paperiteline/Vararullateline  
Toiletten/Reservpapierhalter, Standmodell

H 615 mm / 24 3/16"

4



6

**5 FB636**

Toilet/Spare roll holder, free standing  
Toalett/Reservpappershållare, fristående  
Toilet/Reservpapirholder, frittstående  
Toalett/Reservpapirholder, frittstående  
WC-paperiteline/Vararullateline  
Toiletten/Reservpapierhalter, Standmodell

H 615 mm / 24 3/16"

**6 FX636**

Toilet/Spare roll holder, free standing  
Toalett/Reservpappershållare, fristående  
Toilet/Reservpapirholder, frittstående  
Toalett/Reservpapirholder, frittstående  
WC-paperiteline/Vararullateline  
Toiletten/Reservpapierhalter, Standmodell

H 615 mm / 24 3/16"





**1 FK608**  
Triple swing arm towel rail - Free standing  
Fristående svängbar 3-armed handduksstång  
Svingbar 3-armed handduksstång  
Svingbar 3-armed handduksstång  
Vapaasti seisova 3-osainen kääntyvä pyyhetanko.  
Badetuchhalter Standmodell. 3-armig  
H 780 mm / 31"

**2 FK606**  
Toilet roll holder - Free standing  
Fristående toalettpappershållare  
Fristående toalettpapirholder  
Frittstående toalettpapirholder  
Vapaasti seisova WC-paperiteline  
Toilettenpapierhalter  
H 600 mm / 24"

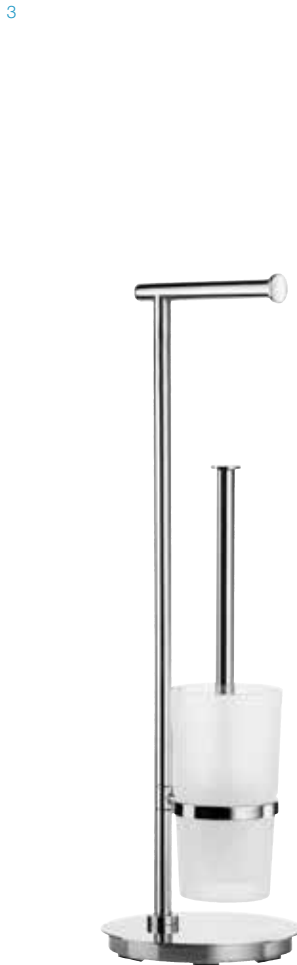

**3 FK607**  
Toilet brush/roll holder - Free standing  
Fristående toalettpappershållare/ WC-borste  
Fristående toalettpapirholder/WC-børste  
Frittstående toalettpapirholder/WC-børste  
Vapaasti seisova WC-paperiteline/ WC-harja  
WC-Standmodell mit Toilettenpapierhalter  
H 600 mm / 24"

**4 FK635**  
Toilet/Spare roll holder, free standing  
Toalett/Reservpappershållare, fristående  
Toilet/Reservpapirholder, fristående  
Toalett/Reservpapirholder, frittstående  
WC-paperiteline/Vararullateline  
Toiletten/Reservpapierhalter. Standmodell  
H 615 mm / 24 3/16"



**5 FB635**  
Toilet/Spare roll holder, free standing  
Toalett/Reservpappershållare, fristående  
Toilet/Reservpapirholder, frittstående  
Toalett/Reservpapirholder, frittstående  
WC-paperiteline/Vararullateline  
Toiletten/Reservpapierhalter. Standmodell  
H 615 mm / 24 3/16"

**6 FX635**  
Toilet/Spare roll holder, free standing  
Toalett/Reservpappershållare, fristående  
Toilet/Reservpapirholder, frittstående  
Toalett/Reservpapirholder, frittstående  
WC-paperiteline/Vararullateline  
Toiletten/Reservpapierhalter. Standmodell  
H 615 mm / 24 3/16"



1



**1 FK605**  
 Toilet brush - Free standing. Round  
 WC-børste. Fristående. Rund  
 WC-børste. Fritstående. Rund  
 WC-børste. Fritstående. Rund  
 WC-harja. Vapaasti seisova. Pyöreä  
 WC-Bürste. Standmodell, rund  
 H 450 mm / 17 3/4"

2



**2 FK634**  
 Towel bar 4 swivel arms  
 Handduksstång. 4 svängbara armar  
 Håndklædestang. 4-armet  
 Håndklestang med 4 svingbare armer  
 Pyyheteline neljällä tangolla.  
 Schwenkbare Handtuchstange  
 H 630 mm / 25"

3



**3 FK630**  
 Seven swivel hooks  
 Handdukskrokar. 7 svängbara på stång  
 Håndklædestang. 7 svingbare kroge  
 Håndklestang. 7 svingbare kroker  
 Pyyheteline. 7 kääntyvää koukkua  
 Schwenkbare Garderobenleiste  
 H 630 mm / 25"



1



1 **FK662**

Pedalbin "Soft close". White  
Pedalhink "Soft close". Vit  
Pedalspand "Soft close". Hvid  
Pedalbøtte "Soft close". Hvit  
Poljinastia "Soft close". Valkoinen  
Pedal-Mülleimer, rund "Soft close". Weiss

6 L  
235 x 320 x 215 mm  
9 1/2" X 12 1/2" X 9"

2



2 **FK663**

Pedalbin "Soft close". Brushed stainless steel  
Pedalhink "Soft close". Borstat rostfritt stål  
Pedalspand "Soft close". Børstet rustfritt stål  
Pedalbøtte "Soft close". Børstet rustfritt stål  
Poljinastia "Soft close". Harjattu ruostumaton teräs  
Pedal-Mülleimer, rund "Soft close". Edelstahl  
gebürstet

6 L  
235 x 320 x 215 mm  
9 1/2" x 12 1/2" x 9"

3



3 **FK665**

Pedalbin "Soft close". Black  
Pedalhink "Soft close". Svart  
Pedalspand "Soft close". Sort  
Pedalbøtte "Soft close". Sort  
Poljinastia "Soft close". Musta  
Pedal-Mülleimer, rund "Soft close". Schwarz

6 L  
235 x 320 x 215 mm  
9 1/2" x 12 1/2" x 9"

**F971**

Bin Liners / Avfallspåsar / Affaldsposer / Avfallsposer / Jätepussit / Abfallbeutel

1



2



3



4



5



**1 FS622**  
 Make-up Mirror with Suction Cups. Magnification X12  
 Sminkspegel med sugproppar. Förstoring X12  
 Sminkespejl med sugekopper. Forstørrelse X12  
 Sminkespeil med sugekopper. Forstørrelse X12  
 Meikkipeili imukupeilla. Suurenus 12-kertainen  
 Kosmetikspiegel mit Saugnapf. Vergrößerung X12  
 Ø 130 mm / 5 1/8"

**2 FS621**  
 Make-up Mirror with Suction Cups. Magnification X12  
 Sminkspegel med sugproppar. Förstoring X12  
 Sminkespejl med sugekopper. Forstørrelse X12  
 Sminkespeil med sugekopper. Forstørrelse X12  
 Meikkipeili imukupeilla. Suurenus 12-kertainen  
 Kosmetikspiegel mit Saugnapf. Vergrößerung X12  
 Ø 90 mm / 3 9/16"

**3 FK620**  
 Plastic mirror with self-adhesive hook  
 Plastspegel med självhäftande krok  
 Plastik spejl med selvklæbende krok  
 Plastspeil med selvklebende krok  
 Muovipeili tarrakiinnitteisellä koukulla  
 Selbstklebender Haken mit wertigem  
 Spiegel aus acryl  
 H 220 mm / 8 11/16"

**4 FB622**  
 Make-up Mirror with Suction Cups. Magnification X12  
 Sminkspegel med sugproppar. Förstoring X12  
 Sminkespejl med sugekopper. Forstørrelse X12  
 Sminkespeil med sugekopper. Forstørrelse X12  
 Meikkipeili imukupeilla. Suurenus 12-kertainen  
 Kosmetikspiegel mit Saugnapf. Vergrößerung X12  
 Ø 130 mm / 5 1/8"

**5 FB621**  
 Make-up Mirror with Suction Cups. Magnification X12  
 Sminkspegel med sugproppar. Förstoring X12  
 Sminkespejl med sugekopper. Forstørrelse X12  
 Sminkespeil med sugekopper. Forstørrelse X12  
 Meikkipeili imukupeilla. Suurenus 12-kertainen  
 Kosmetikspiegel mit Saugnapf. Vergrößerung X12  
 Ø 90 mm / 3 9/16"

CHROMED (FK)  
 SILVER (FS)  
 BLACK (FB)

1



4



2



5



3



6



**1 FB623**

Travel mirror. Magnification X1/X5/X12  
 Resesminkspegel. Förstoring X1/X5/X12  
 Rejsespejl. Forstørrelse X1/X5/X12  
 Reisespeil. Forstørrelse X1/X5/X12  
 Matkapelli. X1/X5/X12 suurennus  
 Reisespiegel. Vergrößerung X1/X5/X12  
 Ø 100 mm / 4"

**2 FX625 (LED)**

Make-up Mirror with Suction Cups. Magnification X7  
 Sminkspegel med sugproppar. Förstoring X7  
 Sminkespejl med sugkopper. Forstørrelse X7  
 Sminkespeil med sugkopper. Forstørrelse X7  
 Meikkipeili imukupeilla. Suurennus 7-kertainen  
 Kosmetikspiegel mit Saugnapf. Vergrößerung X7  
 Ø 120 mm / 4 23/32"

**3 FB627 (LED)**

Travel mirror. Black. Magnification X1/X7  
 Resesminkspegel. Svart. Förstoring X1/X7  
 Rejsespejl. Sort. Forstørrelse X1/X7  
 Reisespeil. Sort. Forstørrelse X1/X7  
 Matkapelli. Musta. X1/X7 suurennus  
 Reisespiegel. Schwarz. Vergrößerung X1/X7  
 Ø 120 mm / 4 23/32"

**4 FX627 (LED)**

Travel mirror. White. Magnification X1/X7  
 Resesminkspegel. Vit. Förstoring X1/X7  
 Rejsespejl. Hvid. Forstørrelse X1/X7  
 Reisespeil. Hvit. Forstørrelse X1/X7  
 Matkapelli. Valkoinen. X1/X7 suurennus  
 Reisespiegel. Weiss. Vergrößerung X1/X7  
 Ø 120 mm / 4 23/32"

**5 FB625 (LED)**

Make-up Mirror with Suction Cups. Magnification X7  
 Sminkspegel med sugproppar. Förstoring X7  
 Sminkespejl med sugkopper. Forstørrelse X7  
 Sminkespeil med sugkopper. Forstørrelse X7  
 Meikkipeili imukupeilla. Suurennus 7-kertainen  
 Kosmetikspiegel mit Saugnapf. Vergrößerung X7  
 Ø 120 mm / 4 23/32"

**6 FX623**

Travel mirror. Magnification X1/X5/X12  
 Resesminkspegel. Förstoring X1/X5/X12  
 Rejsespejl. Forstørrelse X1/X5/X12  
 Reisespeil. Forstørrelse X1/X5/X12  
 Matkapelli. X1/X5/X12 suurennus  
 Reisespiegel. Vergrößerung X1/X5/X12  
 Ø 100 mm / 4"



Rechargeable battery, charge with USB / Batteridreven med batteri laddningsbart via USB / Drevet med genopladeligt batteri, oplades via USB  
 Ladattava akku, lataus USB:llä / Batteridrevet Oppladbar, lades via USB / Akkubetrieben, der über USB aufgeladen werden kann



# POOL



- EN The clean and simple lines of POOL give the bathroom a feeling of international design.
- SE Med sina rena och enkla linjer ger POOL badrummet en känsla av internationell design.
- DK Med sine rene og enkle linjer giver POOL-badeværelset en følelse af internationalt design.
- NO Med sine rene og enkle linjer gir POOL baderommet en følelse av internasjonalt design.
- FI POOL sarjan puhtaat ja yksinkertaiset linjat antavat kylpyhuoneelle kansainvälisen tunnelman.
- DE Die klaren und schlichten Konturen von POOL verleihen dem Bad ein Gefühl von internationalem Design.



POLISHED CHROME (ZK)

1



4



5



2



3



1 **ZK341**  
Toilet roll holder  
Toalettpappershållare  
Toiletppapirholder  
Toalettpapirholder  
WC-paperteline  
Toilettenpapierhalter

2 **ZK320**  
Spare toilet roll holder  
Reservpappershållare  
Reservpapirholder  
Reserverullholder  
Varapaperteline  
Reservpapierhalter  
L 250 mm / 9 7/8"

3 **ZK374**  
Soap basket  
Tvålkorg  
Brusekurv  
Enkel dusjkurv  
Saippukori  
Seifenkorb  
250 x 103 mm. H 70 mm  
8 1/8"W X 2 3/4"H X 8 1/8"D

4 **ZK3414**  
Toilet roll holder with cover  
Toalettpappershållare med lock  
Toiletppapirholder med låg  
Toalettpapirholder med lokk  
WC-paperteline kannella  
Toilettenpapierhalter mit Deckel

5 **ZK332**  
Toilet brush  
WC-borste  
WC-børste  
WC-børste  
WC-harja  
WC-Bürste  
H 435 mm / 17 1/8"



1



4



5



2



3



**1 ZK343 \***

Glass tumbler - Frosted glass  
Tandborstglas med hållare  
Holder med tandkrus  
Tannglass i frostet glass  
Hammasmukitelina. Muki huurrelasia  
Zahnputzbecher

**2 ZK370**

Chrome soap dispenser  
Tvåldispenser  
Sæbedispenser.  
Såpedispenser.  
Saippua-annostelija  
Seifenspender

H 160 mm / 6 1/4"

**3 ZK369 \***

Glass soap dispenser  
Tvåldispenser. Insats av glas  
Sæbedispenser. I materet glas  
Såpedispenser. I frostet glass  
Saippua-annostelija. Pullo huurrelasia  
Seifenspender. Behälter aus Glas

H 180 mm / 7"

**4 ZK342 \***

Soap dish - Frosted glass  
Tvålkopp. Insats av glas  
Sæbeskål. Materet glas.  
Såpekopp i frostet glass  
Saippuakupittelina. Kuppi huurrelasia  
Seifenschale

**5 ZK333 \***

Toilet brush  
WC-borste  
WC-børste  
WC-børste  
WC-harja  
WC-Bürste

H 380 mm / 15"

\* Porcelain parts are available separately / Porslinsdelar finns att köpa separat / Porcelændeile kan købes separat  
Porseleinsdeler kan kjøpes løst / Posliiniosat ovat saatavilla erikseen / Porzellan-Teile separat erhältlich

1



4



6



2



5

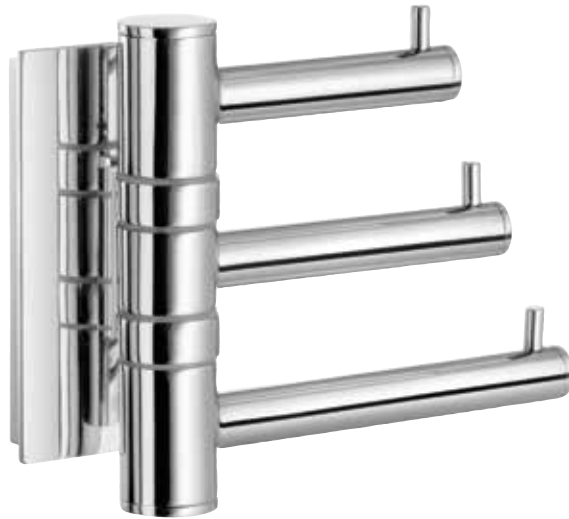

3



**1 ZK3455**  
Towel hook, pair  
Enkelkrok, par  
Krog, par  
Enkelkrok, par  
Nuppikoukkupari  
Handtuchhaken, 2 Stück  
D 31 mm / 1 1/2". Diam 14 mm / 1/2"

**2 ZK344**  
Towel ring  
Handduksring  
Håndklædering  
Håndklæring  
Pypherengas  
Handtuchring  
200 x 120 mm / 8 " x 4 3/4"

**3 ZK325**  
Grab bar  
Badkarshandtag  
Badekarsgreb  
Badekarshåndtak  
Tukikahva  
Wannengriff  
L 250 mm / 10

**4 ZK356**  
Double towel hook  
Dubbel badlakanskrok  
Dobbelt krog  
Dobbelt krok  
Kaksoispyyhekoukku  
Doppelter Badetuchhaken  
H 80 mm / 3 1/8"

**5 ZK327**  
Swing arm triple hook  
Svängbar trippelkrok  
Svingbar trippelkrog  
Svingbar trippelkrok  
Kääntyvä kolmoiskoukku  
Schwenkbarer Dreierhaken  
L 120 mm / 4 3/4". H 95 mm / 3 3/4"

**6 ZK359**  
Triple hook  
Trippelkrok  
Knagerække, 3 kroge  
Kroklist, 3 kroker  
Kolmoiskoukku  
Dreifach Badetuchhaken  
L165 mm / 6 1/2"



1 **ZK326**  
 Swing arm towel rail  
 Svängbar handduksstång  
 Svingbar håndklædestang  
 Svingbar håndklestang  
 Kääntyvä kaksoispyyhetanko  
 Schwenkbare Handtuchstange  
 L 440 mm / 17"

2 **ZK346**  
 Single towel rail  
 Enkel Handduksstång  
 Enkel håndklædestang  
 Enkel håndklestang  
 Pyyhetanko  
 Handtuchstange  
 L 430 mm / 17"

3 **ZK3464**  
 Single towel rail  
 Enkel Handduksstång  
 Enkel håndklædestang  
 Enkel håndklestang  
 Pyyhetanko  
 Handtuchstange  
 L 630 mm / 24"

4 **ZK3364**  
 Double towel rail  
 Dubbel handduksstång  
 Dobbelt håndklædestang  
 Dobbelt håndklestang  
 Kaksoispyyhetanko  
 Doppelte Handtuchstange  
 L 630 mm / 24"

5 **ZK347**  
 Frosted glass shelf - Tempered glass  
 Badrumshylla. Hyllan av frostat säkerhetsglas  
 Badeværelshylde. Hylde i materet glas.  
 Baderomshylle. Hylle i frostat glass  
 Kylpyhuonehylly. Hyilly huurrelasia  
 Badezimmerkonsole Sicherheitsglas matt  
 L 600 mm / 24"



# SIDELINE



- EN SIDELINE shows a range of shower baskets and squeegees of unequalled style and functionality.
- SE Hos duschkorgar och skrapor i SIDELINE förenas form och funktion på ett perfekt och stilfullt sätt.
- DK Brusekurve og badskrabere i SIDELINE kombinerer form og funktion på en perfekt og stilfuld måde.
- NO Med dusjkurver og dusjnalere i SIDELINE forenes form og funksjon på en perfekt og stilfull måte.
- FI SIDELINE sarjan suihkukorit tarjoavat laajan ja joustavan valikoiman koreja, täyttäen samalla toiminnallisuuden ja tyylilykkyyden asettamat vaatimukset.
- DE SIDELINE zeigt eine Auswahl von Dusch- und Badekörben in einzigartigem Design und Funktionalität.



POLISHED CHROME (DK)  
BRUSHED CHROME (DS)  
POLISHED BRASS (DV)  
BRUSHED BRASS (DV-S)  
BLACK (DB)  
WHITE (DX)

1

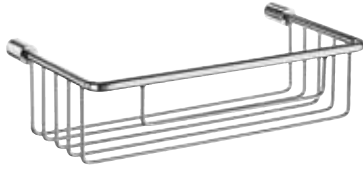

2

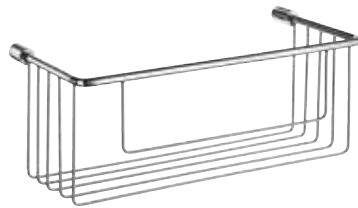

3



4



5



6

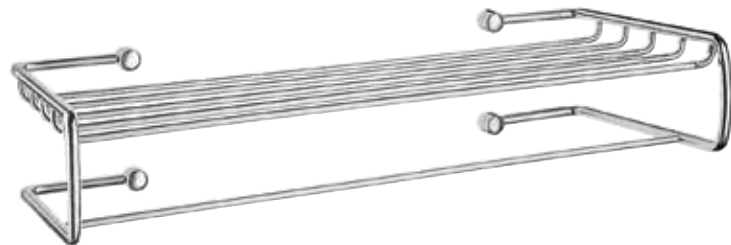

7

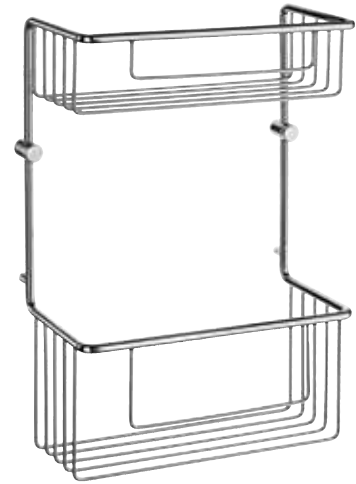

**1 DK1001**  
 Basic soap basket  
 Basic tvålkorg  
 Basic brusekurv  
 Basic dusjkurv  
 Basic saippuakori  
 Basic Seifenkorb  
 215 x 117 mm. H 60 mm  
 8 1/2"W x 2 1/2"H x 4 3/4"D

**2 DK1002**  
 Basic soap basket  
 Basic tvålkorg  
 Basic brusekurv  
 Basic dusjkurv  
 Basic saippuakori  
 Basic Seifenkorb  
 267 x 117 mm. H 105 mm  
 10 1/2"W x 4 1/2"H x 4 3/4"D

**3 DK1005**  
 Basic soap basket  
 Basic tvålkorg  
 Basic brusekurv  
 Basic dusjkurv  
 Basic saippuakori  
 Basic Seifenkorb  
 135 x 95 mm. H 22 mm  
 5 1/2"W x 3 1/4"H x 7/8"D

**4 DK1021**  
 Basic corner soap basket -two levels  
 Basic hörntvålkorg  
 Basic hjørne brusekurv  
 Basic dusjkurv for hjørne  
 Basic kaksoiskulmakori  
 Basic Eckseifenkorb  
 165 x 165 mm. H 295 mm  
 6 1/2"W x 11 1/2"H x 6 1/2"D

**5 DK1022**  
 Basic corner soap basket -two levels  
 Basic hörntvålkorg  
 Basic hjørne brusekurv  
 Basic dusjkurv for hjørne  
 Basic kaksoiskulmakori  
 Basic Eckseifenkorb  
 207 x 207 mm. H 295 mm  
 8 1/4"W x 11 1/2"H x 8 1/4"D

**6 DK1050**  
 Towel rack and rail  
 Handdukshylla med handduksstång  
 Håndklædehylde med håndklædestang  
 Håndklehylla med håndklestang  
 Pyyhehylly yhdellä pyyhetangolla  
 Handtuchablage mit Badetuchhalter  
 500 x 260 mm. H 95 mm  
 20"W x 3 3/4"H x 10 1/4"D

**7 DK1031**  
 Basic soap basket - two levels  
 Basic tvålkorg dubbel  
 Basic brusekurv. Dobbelt  
 Basic dusjkurv. Dobbel  
 Basic kaksoiskori  
 Basic Seifenkorb doppelt  
 215 x 110 mm. H 320 mm  
 8 1/2"W x 12 1/2"H x 4 1/2"D



**1 DK3041**  
 Shower basket - two levels  
 Duschkorg dubbel  
 Dobbelt brusekurv  
 Dobbelt dusjkurv  
 Kaksois saippuakori  
 Duschkorb doppelt  
 250 x 103 mm, H 765 mm  
 8"W x 30"H x 8"D

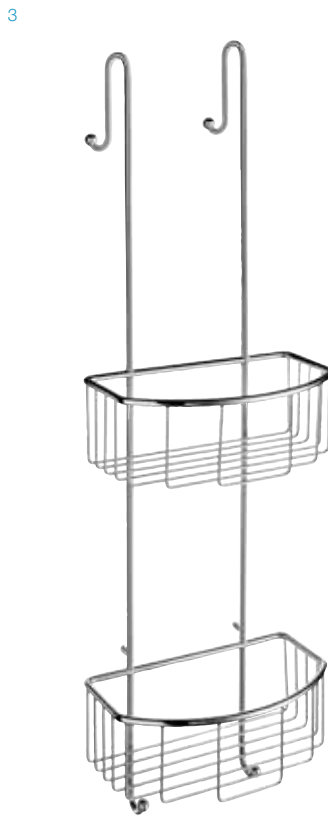

**2 DK1048**  
 Soap basket for shower mixer  
 Tvålkorg för duschblandare  
 Brusekurv til bruseblandere  
 Dusjkurv for dusjblandebatteri  
 Saippuakori suihkusekoittajaan  
 Duschkorb für Duscharmaturen  
 217 x 134 mm  
 9"W x 5 1/8"D

**3 DK1041**  
 Basic shower basket - two levels  
 Basic duschkorg dubbel  
 Basic Dobbelt brusekurv  
 Basic Dobbelt dusjkurv  
 Basic kaksois saippuakori  
 Basic Duschkorb doppelt  
 220 x 130 mm, H 765 mm  
 8 5/8"W x 30"H x 5 1/8"D



**4 DK3048**  
 Shower basket for shower mixer  
 Tvålkorg för duschblandare  
 Brusekurv til bruseblandere  
 Dusjkurv for dusjblandebatteri  
 Saippuakori suihkusekoittajaan  
 Duschkorb für Duscharmaturen  
 250 x 103 mm  
 10"W x 4"D

**5 DB3041**  
 Shower basket - two levels  
 Duschkorg dubbel  
 Dobbelt brusekurv  
 Dobbelt dusjkurv  
 Kaksois saippuakori  
 Duschkorb doppelt  
 250 x 103 mm, H 765 mm  
 8"W x 30"H x 8"D

1

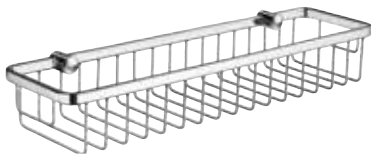

3



6

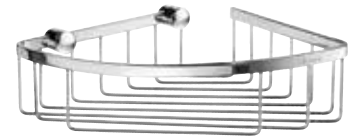

2



4



7

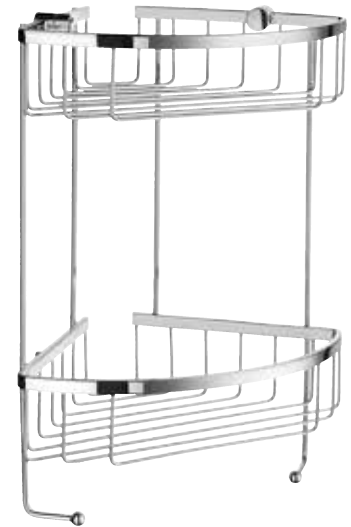

5



**1 DK2005**

Design soap basket  
Design tvålkorg  
Design brusekurv  
Design enkel dusjkurv  
Design saippuakori  
Design Seifenkorb

400 x 115 mm. H 60 mm  
13 3/4"W x 2 1/2"H x 4 1/2"D

**2 DK2041**

Design corner soap basket - two levels  
Design hörntvålkorg dubbel  
Design dobbelt hjørne brusekurv  
Design dobbel dusjkurv for hjørne  
Design kaksoiskulmakori  
Design Eckseifenkorb doppelt

195 x 195 mm. H 295 mm  
7 5/8"W x 11 5/8"H x 7 5/8"D

**3 DK2001 / DS2001**

Design Soap Basket  
Design tvålkorg  
Design brusekurv  
Design enkel dusjkurv  
Design saippuakori  
Design Seifenkorb

250 x 110 mm. H 60 mm  
10"W x 2 1/2"H x 4 3/8"D

**4 DK3055**

Design corner soap basket  
Design hörntvålkorg  
Design hjørne brusekurv  
Design dusjkurv for hjørne  
Design kulmakori  
Design Eckseifenkorb

205 x 205 mm. H 60 mm  
8 1/8"W x 2 3/8"H x 8 1/8"D

**5 DK3025**

Design corner soap basket  
Design hörntvålkorg  
Design hjørne brusekurv  
Design dusjkurv for hjørne  
Design kulmakori  
Design Eckseifenkorb

200 x 200 mm. H 70 mm.  
8"W x 2 3/4"H x 8"D

**6 DK2021 / DS2021**

Design corner soap basket  
Design hörntvålkorg  
Design hjørne brusekurv  
Design dusjkurv for hjørne  
Design kulmakori  
Design Eckseifenkorb

195 x 195 mm. H 60 mm  
7 5/8"W x 2 1/2"H x 7 5/8"D

**7 DK2031 / DS2031**

Design corner soap basket - two levels  
Design hörntvålkorg dubbel  
Design dobbelt hjørne brusekurv  
Design dobbel dusjkurv for hjørne  
Design kaksoiskulmakori  
Design Eckseifenkorb doppelt

195 x 195 mm. H 60 mm  
7 5/8"W x 2 1/2"H x 7 5/8"D



1



3



5



2

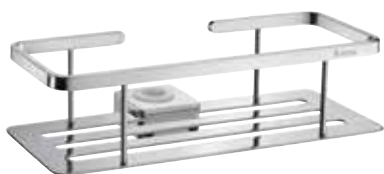

4



6



**1 DK3012**

Design soap basket - two levels  
Design tvålkorg dubbel  
Design brusekurv. Dobbel  
Design dusjkurv. Dobbel  
Design kaksoiskori  
Design Seifenkorb doppelt

250 x 103 mm. H 322 mm  
8 1/2"W x 12 5/8"H x 4 1/2"D

**2 DK3006**

Basket for shower riser rail.  
Tvålkorg för duschstång.  
Brusekurv til brusestang.  
Såpekurv til dusjstang.  
Kori suihkutankoon.  
Korb für die Brausestange.

250 x 103/139 mm. H 60/78 mm  
10"W X 2 1/2"H X 4"D  
Ø 18, 22, 24, 25 mm. 3/4", 7/8", 1"

**3 DB3031 / DK3031**

Design corner soap basket  
Design hörntvålkorg  
Design hjørne brusekurv  
Design dusjkurv for hjørne  
Design kulmakori  
Design Eckseifenkorb

200 x 200 mm. H 70 mm  
8"W x 2 3/4"H x 8"D

**4 DB3006**

Basket for shower riser rail.  
Tvålkorg för duschstång.  
Brusekurv til brusestang.  
Såpekurv til dusjstang.  
Kori suihkutankoon.  
Korb für die Brausestange.

250 x 103/139 mm. H 60/78 mm  
10"W X 2 1/2"H X 4"D  
Ø 18, 22, 24, 25 mm. 3/4", 7/8", 1"

**5 DK3032**

Design corner soap basket - two levels  
Design hörntvålkorg dubbel  
Design dobbelt hjørne brusekurv  
Design dobbel dusjkurv for hjørne  
Design kaksoiskulmakori  
Design Eckseifenkorb doppelt

200 x 200 mm. H 322 mm  
8"W x 12 5/8"H x 8"D

**6 DB3060 / DK3060**

Grout line corner shelf  
Hörnhylla för inkakling  
Hjørnehyllde for indmuring  
Hjørnehylle for flisvegg  
Kulmahylly  
Eckregal für Fliesen

200 x 200 mm  
8"W x 8"D

1



4



2



5



3



6



**1 DK3061**  
Grout line shelf  
Hylla för inkakling  
Hylde for indmuring  
Hylle for flisvegg  
Suihkuhyilly laattasaamaan  
Regal zum Einfliesen

250 x 100 mm  
10"W x 4"D

**2 DB3062**  
Grout line shelf  
Hylla för inkakling  
Hylde for indmuring  
Hylle for flisvegg  
Suihkuhyilly laattasaamaan  
Regal zum Einfliesen

250 x 100 mm  
10"W x 4"D

**3 DK5001**  
Shower Shelf  
Duschhylla  
Brusehylde  
Duschhylle  
Suihkuhyilly  
Duschregal

250 x 112 mm. H 47 mm  
10"W x 2"H x 4.5"D

**4 DB3061**  
Grout line shelf  
Hylla för inkakling  
Hylde for indmuring  
Hylle for flisvegg  
Suihkuhyilly laattasaamaan  
Regal zum Einfliesen

250 x 100 mm  
10"W x 4"D

**5 DK3062**  
Grout line shelf  
Hylla för inkakling  
Hylde for indmuring  
Hylle for flisvegg  
Suihkuhyilly laattasaamaan  
Regal zum Einfliesen

250 x 100 mm  
10"W x 4"D

**6 DB5001**  
Shower Shelf  
Duschhylla  
Brusehylde  
Duschhylle  
Suihkuhyilly  
Duschregal

250 x 112 mm. H 47 mm  
10"W X 2"H X 4.5"D

1



4



2



5



3



6



**1 DK3063**  
Grout line corner shelf  
Hörnhylla för inkakling  
Hjørnehylde for indmuring  
Hjørnehylle for flisvegg  
Kulmahylly laattasaumaan  
Eckregal zum Einfliesen

200 x 200 mm  
8"W x 8"D

**2 DB3064**  
Grout line corner shelf  
Hörnhylla för inkakling  
Hjørnehylde for indmuring  
Hjørnehylle for flisvegg  
Kulmahylly laattasaumaan  
Eckregal zum Einfliesen

200 x 200 mm  
8"W x 8"D

**3 DB5011**  
Corner Shower shelf  
Hörnduschhylla  
Brusehylde for hjørne  
Hjørnedusjhylle  
Kulmahylly  
Eckregal

210 x 210 mm. H 47 mm  
8.25"W x 8.25"D x 2"H

**4 DB3063**  
Grout line corner shelf  
Hörnhylla för inkakling  
Hjørnehylde for indmuring  
Hjørnehylle for flisvegg  
Kulmahylly laattasaumaan  
Eckregal zum Einfliesen

200 x 200 mm  
8"W x 8"D

**5 DK3064**  
Grout line corner shelf  
Hörnhylla för inkakling  
Hjørnehylde for indmuring  
Hjørnehylle for flisvegg  
Kulmahylly laattasaumaan  
Eckregal zum Einfliesen

200 x 200 mm  
8"W x 8"D

**6 DK5011**  
Corner Shower shelf  
Hörnduschhylla  
Brusehylde for hjørne  
Hjørnedusjhylle  
Kulmahylly  
Eckregal

210 x 210 mm. H 47 mm  
8.25"W x 8.25"D x 2"H

1



5



2



3

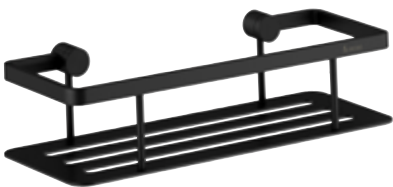

4

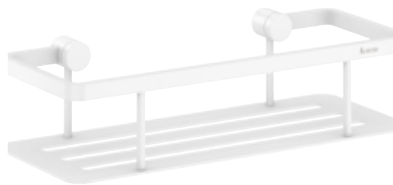

6

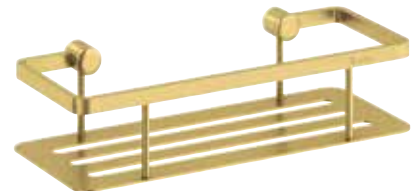

**1 DK3001**  
 Design soap basket  
 Design tvålkorg  
 Design Sæbekurv  
 Design Sâpekurv  
 Design saippuakori  
 Design Seifenkorb  
 250 x 103 mm. H 60 mm  
 10"W X 2 1/2"H X 4"D

**3 DB3001**  
 Design soap basket  
 Design tvålkorg  
 Design Sæbekurv  
 Design Sâpekurv  
 Design saippuakori  
 Design Seifenkorb  
 250 x 103 mm. H 60 mm  
 10"W x 2 1/2"H x 4"D

**5 DK3005**  
 Design soap basket  
 Design tvålkorg  
 Design Sæbekurv  
 Design Sâpekurv  
 Design saippuakori  
 Design Seifenkorb  
 400 x 103 mm. H 70 mm  
 16"W x 2 3/4"H x 4"D

**2 DV3001**  
 Design soap basket  
 Design tvålkorg  
 Design Sæbekurv  
 Design Sâpekurv  
 Design saippuakori  
 Design Seifenkorb  
 250 x 103 mm. H 60 mm  
 10"W x 2 1/2"H x 4"D

**4 DX3001**  
 Design soap basket  
 Design tvålkorg  
 Design Sæbekurv  
 Design Sâpekurv  
 Design saippuakori  
 Design Seifenkorb  
 250 x 103 mm. H 60 mm  
 10"W x 2 1/2"H x 4"D

**6 DV3001S**  
 Design soap basket  
 Design tvålkorg  
 Design Sæbekurv  
 Design Sâpekurv  
 Design saippuakori  
 Design Seifenkorb  
 250 x 103 mm. H 60 mm  
 10"W X 2 1/2"H X 4"D



3

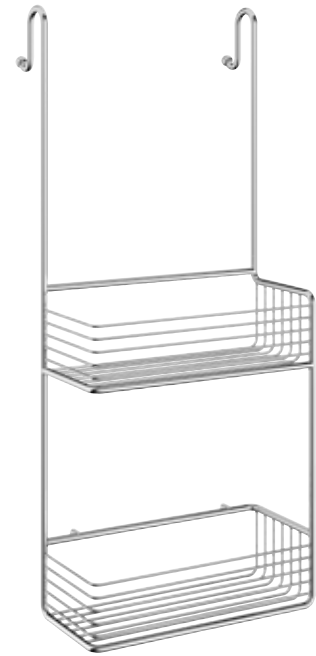

1



2



4

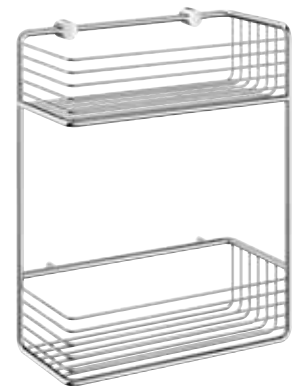

**1 DK1101**

Soap Basket  
Duschkorg  
Brusekurv  
Enkel dusjkurv  
Suihkukori  
Seifenkorb

250 x 100 mm. H 70 mm  
9 27/32"W x 2 3/4"H x 3 15/16"D

**2 DK1106**

Basket for shower riser rail.  
Tvålkorg för duschstång.  
Brusekurv til brusestang.  
Såpekurv til dusjstang.  
Kori suihkutankoon.  
Korb für die Brausestange.

250 x 100 mm. H 70 mm  
9 27/32"W x 2 3/4"H x 3 15/16"D

**3 DK1141**

Shower basket - two levels  
Duschkorg dubbel  
Dobbelt brusekurv  
Dobbelt dusjkurv  
Kaksois saippuakori  
Duschkorb doppelt

250 x 100 mm. H 596 mm  
9 27/32"W x 23 15/32"H x 3 15/16"D

**4 DK1111**

Shower basket - two levels  
Duschkorg dubbel  
Dobbelt brusekurv  
Dobbelt dusjkurv  
Kaksois saippuakori  
Duschkorb doppelt

250 x 100 mm. H 310 mm  
9 27/32"W x 12 13/64"H x 3 15/16"D

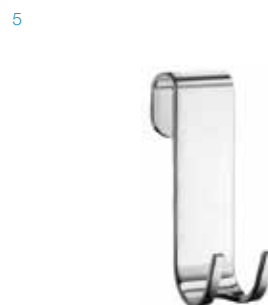
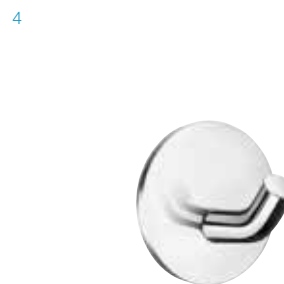
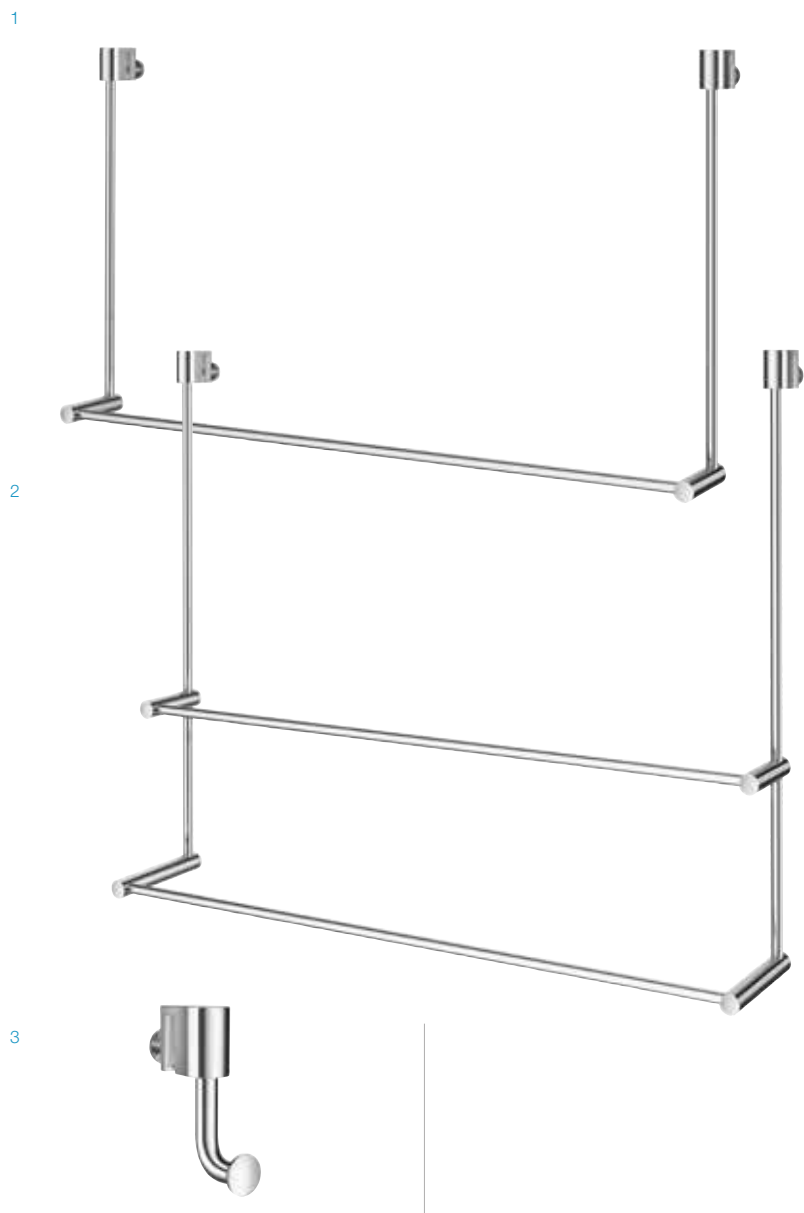

**1 DK3101**  
Towel rail for glass shower panel  
Handdukuhängare för duschvägg  
Håndklædestang til glas brusevæg  
Enkel håndklestang. For glass dusjkabinett  
Pyyhetanko suihkuseinään  
Håndkleholder til dusjvegg  
600 x 330 mm 23 5/8"W x 13"H

**2 DK3102**  
Double towel rail for glass shower panel  
Dubbel handdukuhängare för duschvägg  
Dobbel håndklædestang til glas brusevæg  
Dobbel håndkleholder til dusjvegg  
Kaksoispyyhetanko suihkuseinään  
Doppelhandtuchhalter für Glasduschwand  
600 x 485 mm 23 5/8"W x 19 1/16"H

**3 DK3111**  
Hook for glass shower panel  
Krok för duschvägg  
Enkelkrog til brusevæg  
Krok til dusjvegg  
Koukku suihkuseinään  
Haken für Glasduschwand  
H 80 x D 40 mm  
3 1/8"H x 1 9/16"D

**4 DK2113**  
Self-adhesive Hook  
Självhäftande enkelkrok  
Selvklæbende krog  
Selvklebende enkelkrok  
Tarrakinnitteinen koukku  
Selbstklebende Haken  
Ø 48 mm  
1 7/8"

**5 DK2111**  
Hook (shower enclosure) for soap basket  
Påhängskrok till duschvägg och tvålorgar  
Påhängskrog til brusekurve  
Krok til dusjkurv  
Sideline Design saippuakorikoukku  
Haken für Smedbo Seifenkörbe  
H 95 mm / 3 3/4"

**6 DK2100**  
Soap basket hook  
Påhängskrok  
Påhängskrog till dusjkurve  
Krok til dusjkurv  
Sideline Basic saippuakorikoukku  
Haken für Smedbo Seifenkörbe  
H 41 mm / 1 5/8"



**1 DK2150**  
 Shower squeegee  
 Duschskrapa  
 Bruserskraber  
 Dusjnal  
 Suihkulasta.  
 Duschabzieher  
 240 x 210 mm / 9 1/2" x 8 1/4"

**2 DB2145**  
 Shower Squeegee. Black ABS/silicone  
 Duschskrapa. Svart ABS/silikon  
 Bruserskraber. Sort ABS/silikon  
 Dusjnal. Sort ABS/silikon  
 Suihkulasta. Musta ABS/silikoni  
 Duschabzieher. Schwarz ABS/Silikon  
 L 240 mm / 9 1/2"

**3 DK2165**  
 Shower squeegee. Extra long  
 Duschskrapa. Extra lång  
 Bruserskraber. Ekstra lang  
 Dusjnal. Ekstra lang  
 Suihkulasta pitkällä varrella  
 Duschabzieher. Mit verlängertem Griff  
 240 x 495 mm / 9 7/16" X 19 1/2"

**4 DB2142 / DK2142**  
 Shower squeegee  
 Duschskrapa  
 Bruserskraber  
 Dusjnal  
 Suihkulasta  
 Duschabzieher  
 240 x 400 mm / 9 1/2" x 15.75"

**5 DX2145**  
 Shower Squeegee. White ABS/Silicone  
 Duschskrapa. Vit ABS/silikon  
 Bruserskraber. Hvid ABS/silikon  
 Dusjnal. Hvit ABS/silikon  
 Suihkulasta. Valkoinen ABS/silikoni  
 Duschabzieher. Weiss ABS/Silikon  
 L 240 mm / 9 1/2"

**6 DK2140 / DB2140**  
 Shower squeegee  
 Duschskrapa  
 Bruserskraber  
 Dusjnal  
 Suihkulasta.  
 Duschabzieher  
 240 x 210 mm  
 9 7/16" X 8 1/4"

**7 DK2130**  
 Shower Squeegee. Chrome/ABS/Silicone  
 Duschskrapa. Krom/ABS/silikon  
 Bruserskraber. Krom/ABS/silikon  
 Dusjnal. Krom/ABS/silikon  
 Suihkulasta. Kromi/ABS/silikoni  
 Duschabzieher. Chrom/ABS/Silikon  
 L 248 mm/ 9 3/4"

# VILLA



- EN Unmistakably traditional, VILLA is the most classically elegant of all the Smedbo ranges.
- SE Med tydligt traditionell design är VILLA vår mest klassiskt eleganta serie.
- DK Med klart traditionelt design er VILLA vores mest klassisk elegante serie.
- NO Med tydelig tradisjonell design er VILLA vår mest klassisk elegante serie.
- FI VILLA. Erehtymättömästi perinteinen, klassisin kaikista Smedbon tuotesarjoista.
- DE Unverwechselbar traditionell, ist VILLA die klassisch eleganteste aller Smedbo-Serien.



POLISHED CHROME (K)  
POLISHED BRASS (V)



1



2



3



4



5



1 **K245 / V245**  
Towel hook  
Enkelkrok  
Krog  
Enkelkrok  
Pyyhekoukku  
Handtuchhaken  
Ø 55 mm / 2 1/4"

2 **K255 / V255**  
Towel hook  
Enkelkrok  
Krog  
Enkelkrok  
Pyyhekoukku  
Handtuchhaken  
Ø 70 mm / 2 3/4"

3 **K256 / V256**  
Double towel hook  
Dubbel badlakanskrok  
Dobbelt krog  
Dobbel krok  
Kaksoispyyhekoukku  
Doppelter Badetuchhaken  
Ø 70 mm / 2 3/4"

4 **K274 / V274**  
Corner soap basket  
Hörntvålkor  
Hjørne brusekurv  
Dusjkurv for hjørne  
Kulmakori  
Eckseifenkorb  
200 x 200 mm. H 60 mm  
7 3/4"W x 7 3/4"D x 2 1/2"H

5 **K259 / V259**  
Quadruple hook  
Fyrkrok  
Firekrog  
Kroklist, 4 kroker  
Nelikkoukkusarja  
Viererhakenleiste  
L 230 mm / 9"

1



2



3



4



5



6



- 1 **K241 / V241**  
Toilet roll holder  
Toalettpappershållare  
Toiletpaperholder  
Toalettpapirholder  
WC-paperiteline  
Toilettenpapierhalter

- 2 **K242 / V242**  
Soap dish - glass  
Tvålkopp. Insats av glas  
Sæbeskål. I glas.  
Såpekopp. I glass  
Saippuakupitteline. Kuppi lasia  
Seifenschale

- 3 **K243 / V243**  
Glass tumbler - glass  
Tandborstglas med hållare  
Holder med tandkrus  
Holder med tannglass  
Hammasmukiteline. Muki Lasia  
Zahnputzbecher

- 4 **K269**  
Glass soap dispenser  
Tvåldispenser. Insats av glas  
Sæbedispenser. I materet glas  
Såpedispenser. I frostet glass  
Saippua-annostelija. Pullo huurrelasia  
Seifenspender. Behälter aus Glas  
160 mm / 6 1/2"

- 5 **K220 / V220**  
Spare toilet roll holder  
Reservpappershållare  
Reservepaperholder  
Reserverullholder  
WC-varapaperiteline  
Reservepapierhalter  
H 175 mm / 7"

- 6 **K233 / V233**  
Toilet brush, Free standing  
WC-børste, frittstående  
WC-børste, frittstående  
WC-børste, frittstående  
WC-Harja, vapaasti seisova  
WC-Bürste, Freistehend  
H 425 mm / 16 3/4"

1



4

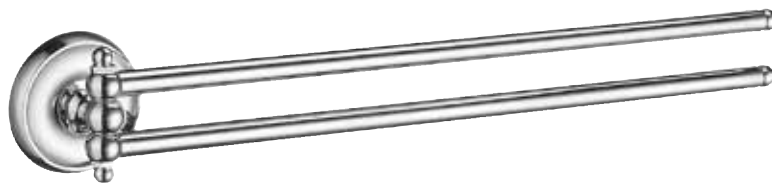

5



2



3



6



1 **K225 / V225**  
 Grab bar  
 Badkarshandtag  
 Badekarsgreb  
 Badekarshåndtak  
 Tukikahva  
 Wannengriff  
 L 275 mm / 10 7/8"

2 **K2464 / V2464**  
 Single towel rail  
 Enkel Handduksstång  
 Enkel håndklædestang  
 Enkel håndklestang  
 Pyyhetanko  
 Handtuchstange  
 L 635 mm / 24"

3 **K2364 / V2364**  
 Double towel rail  
 Dubbel handduksstång  
 Dobbelt håndklædestang  
 Dobbelt håndklestang  
 Kaksoispyyhetanko  
 Doppelte Handtuchstange  
 L 635 mm / 24 4/5"

4 **K226 / V226**  
 Swing arm towel rail  
 Svängbar handduksstång  
 Svingbar håndklædestang  
 Svingbar håndklestang  
 Kääntyvä kaksoispyyhetanko  
 Schwenkbare Handtuchstange  
 L 440 mm / 17"

5 **K247 / V247**  
 Clear glass shelf - tempered glass  
 Badrumshylla. Hyllan av klart säkerhetsglas  
 Badeværelseshylde. Hylde i materet glas.  
 Baderomshylle. Hylle i frostet glass  
 Kylpyhuonehylly. Hylly lasia  
 Badezimmerkonsole Sicherheitsglas  
 L 600 mm / 24"

6 **K244 / V244**  
 Towel ring  
 Handduksring  
 Håndklædering  
 Håndklæring  
 Handtuchring  
 Pyyherengas  
 Ø 155 mm / 6"



# XTRA



- EN Spare parts and extra accessories for your bathroom.
- SE Reservdelar och extra tillbehör för badrummet.
- DK Reservedele og tilbehør til badeværelset.
- NO Reservedeler og ekstra tilbehør til baderommet.
- FI Vara- ja lisäosia kylpyhuoneeseen.
- DE Ersatzteile und extra Zubehör für Ihr Bad.



1



2



3



4



5



6



7



8



9



10



11



**1 O334**  
Spare glass, porcelain  
Reservglas, porslin  
Løs beholder i porcelæn  
Løs beholder i porselen  
Varalasi, Posliini  
Porzellan-Ersatzbehälter für WC Bürste  
AK, HB/HK/HS/HV, RB/RK/RS/RV/RX,  
OK, ZK #333

**2 O351**  
Spare glass, porcelain  
Reservglas, porslin  
Løs beholder i porcelæn  
Løs beholder i porselen  
Varalasi, Posliini  
Porzellan-Ersatzbehälter für Seifenspender  
AK, HB/HK/HS/HV, RB/RK/RS/RV/RX,  
OK, ZK, #369

**3 O348**  
Spare glass, porcelain  
Reservglas, porslin  
Løs beholder i porcelæn  
Løs beholder i porselen  
Varalasi, Posliini  
Ersatzseifenschale, Porzellan  
AK, HB/HK/HS/HV, RB/RK/RS/RV/RX,  
OK, ZK #342

**4 O349**  
Spare glass, porcelain  
Reservglas, porslin  
Løs beholder i porcelæn  
Løs beholder i porselen  
Varalasi, Posliini  
Porzellan-Ersatzbecher  
AK, HB/HK/HS/HV, RB/RK/RS/  
RV/RX, OK, ZK #343

**5 L348**  
Spare glass  
Reservglas  
Løs beholder i materet glas  
Løs beholder i frostet glass  
Varalasi, huurrelasia  
Ersatzseifenschale  
AK, HB/HK/HS/HV, RB/RK/RS/RV/RX,  
OK, ZK #342

**6 L349**  
Spare glass  
Reservglas  
Løs beholder i materet glas  
Løs beholder i frostet glass  
Varalasi, huurrelasia  
Ersatzbecher  
AK, HB/HK/HS/HV, RB/RK/RS/RV/RX,  
OK, ZK #343

**7 V248G**  
Spare glass  
Reservglas  
Løs beholder i glas  
Løs beholder i glass  
Varalasi  
Ersatzseifenschale  
#242

**8 V249G**  
Spare glass  
Reservglas  
Løs beholder i glas  
Løs beholder i glass  
Varalasi  
Ersatzbecher  
#243

**9 N334**  
Spare glass  
Reservglas  
Løs beholder i materet glas  
Løs beholder i frostet glass  
Varalasi, huurrelasia  
Ersatzglas für WC-Bürste  
#333, FK101, FK603/607

**10 H351**  
Spare glass  
Reservglas  
Løs beholder i materet glas  
Løs beholder i frostet glass  
Varalasi, huurrelasia  
Ersatzbecher  
AK, HB/HK/HS/HV, RB/RK/RS/RV/RX,  
OK, ZK #369

**11 N3351**  
Spare glass  
Reservglas  
Løs beholder i materet glas  
Løs beholder i frostet glass  
Varalasi, huurrelasia  
Ersatzbecher  
FK201, #269

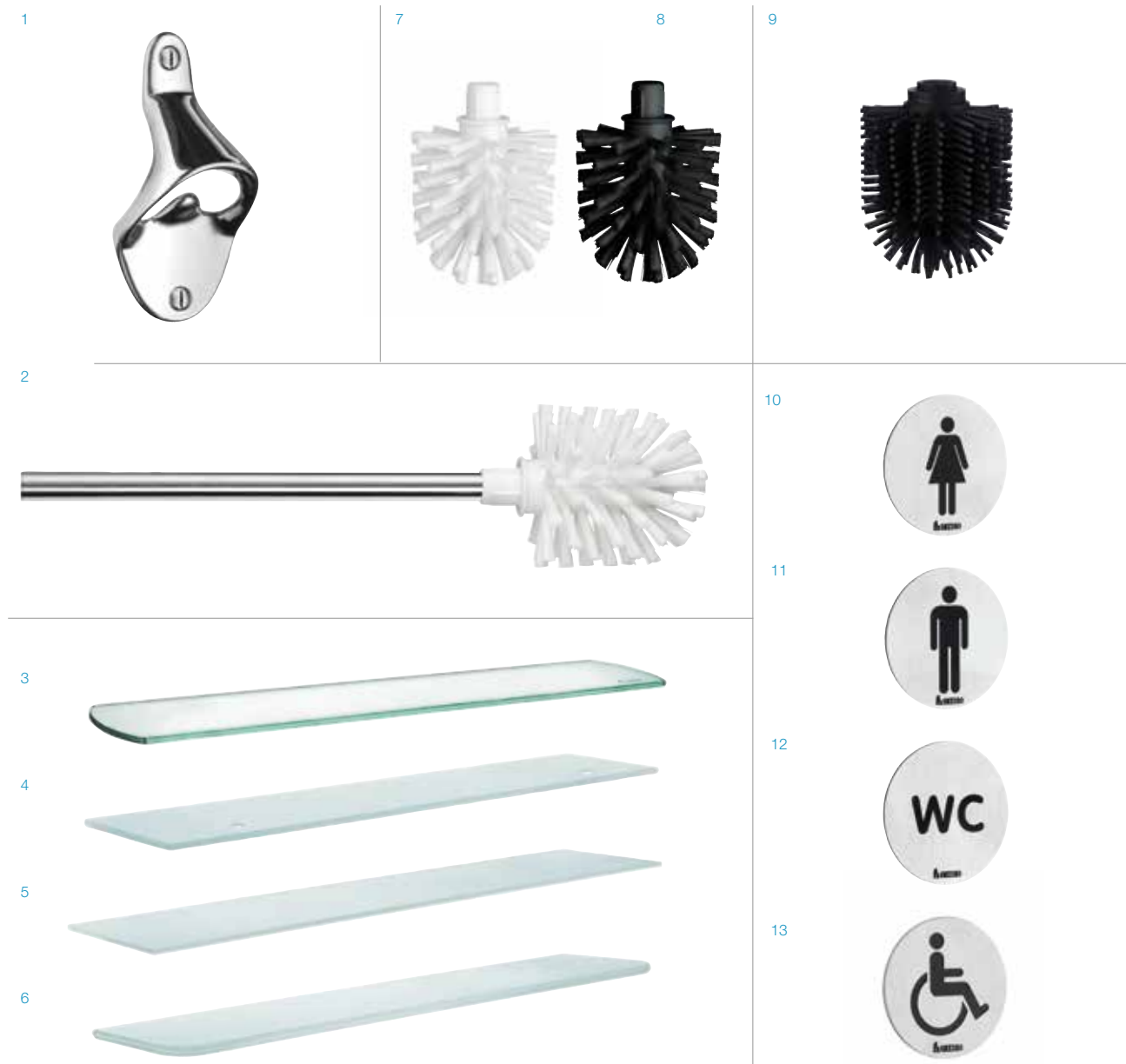

**1 FK970**  
Bottleopener  
Kapsylöppnare  
Oplukker  
Korkåpner  
Pullonavaaja  
Flaschenöffner

**2 HK237 / HS237**  
Spare brush with handle  
WC-børste med skaft  
Løs hvid børstehoved med stang  
WC-børste med stang  
Valkoinen WC-harja varrella  
Ersatz WC-Bürste mit Stiel

**3 N350**  
Spare glass  
Reservglas  
Løs hylde i glas  
Løs glasshylle  
Varalasi  
Ersatzkonsole  
#247

**4 H350**  
Spare glass  
Reservglas  
Løs hylde i materet glas  
Løs hylde i frostet glass  
Varalasi, huurrelasia  
Ersatzkonsole  
*HK/HHS, RK/RS347*

**5 P350**  
Spare glass  
Reservglas  
Løs hylde i materet glas  
Løs hylde i frostet glass  
Varalasi, huurrelasia  
Ersatzkonsole  
*AK, ZK347*

**6 OK350**  
Spare glass  
Reservglas  
Løs hylde i materet glas  
Løs hylde i frostet glass  
Varalasi, huurrelasia  
Ersatzkonsole  
*OK347*

**7 H234N**  
Spare white brush  
Reservborste vit  
Løs børste hvid  
Løs børste hvit  
Varaharja valkoinen  
Ersatzbürstenkopf weiss  
#332, #333, FK101, #233,  
FK603, FK607

**8 H233N**  
Spare black brush  
Reservborste svart  
Løs børste sort  
Løs børste sort  
Varaharja musta  
Ersatzbürstenkopf schwarz  
#332, #333, FK101, #233,  
FK603, FK607

**9 H235S**  
Spare black brush. TPR  
Reservborste svart. TPR  
Løs børste sort. TPR  
Løs børste sort. TPR  
Varaharja musta. TPR  
Ersatzbürstenkopf schwarz. TPR  
#332, #333, FK101, #233,  
FK603, FK607

**10 FS956 \***  
WC Sign Lady  
WC-skyilt Dam  
WC skilt Dame  
WC skilt Dame  
WC-kylitti Naiset  
WC-Schild Damen

**11 FS957 \***  
WC Sign Gentleman  
WC-skyilt Herr  
WC skilt Herre  
WC skilt Herre  
WC-kylitti Miehet  
WC-Schild Herren

**12 FS958 \***  
WC Sign WC  
WC-skyilt WC  
WC skilt  
WC skilt  
WC-kylitti WC  
WC-Schild WC

**13 FS959 \***  
WC Sign Disabled  
WC-skyilt Funktionshindra  
WC skilt Handicap  
WC skilt Handikap  
WC-kylitti Liikuntarajoitteinen  
WC-Schild Behinderten WC

\* Self-adhesive / Självhäftande / Selvklebende  
Selvklebende / Tarrakiinnitys / Selbstklebend

1



5



6



2



7



3



4



8



**1 YK380**  
 Clock, Black. Self-adhesive.  
 Klocka, svart. Självhäftande.  
 Klokke, sort. Selvklebende.  
 Klokke, sort. Selvklebende.  
 Kello, musta. Tarrakiinnitys.  
 Badezimmeruhr, Selbstklebend.  
 Ø 60 mm / 2 1/2"

**5 F971**  
 Trash bags for OUTLINE LITE pedal bin  
 Påsar till OUTLINE LITE pedalhink  
 Poser til OUTLINE LITE pedalspand  
 Poser til OUTLINE LITE pedalbøtte  
 OUTLINE LITE, Pussit poljinastialle  
 Reissfeste Abfallbeutel, für OUTLINE LITE

**6 YX380**  
 Clock, White. Self-adhesive.  
 Klocka, vit. Självhäftande.  
 Klokke, hvid. Selvklebende.  
 Klokke, hvid. Selvklebende.  
 Kello, valkoinen. Tarrakiinnitys.  
 Badezimmeruhr, Selbstklebend.  
 Ø 60 mm / 2 1/2"

**2 6000-10**  
 iComposite Gluemix. Glue  
 iComposite Gluemix. Lim  
 iComposite Gluemix. Lim  
 iComposite Gluemix. Lim  
 iComposite Gluemix. Liima  
 iComposite Gluemix. Kleber

**7 6000-11**  
 iComposite iCleaner Cleaning Cloth  
 iComposite iCleaner rengöringsduk  
 iComposite iCleaner rengöringsklud  
 iComposite iCleaner rengöringsklut  
 iComposite iCleaner puhdistusliina  
 iComposite iCleaner Reinigungstuch

**3 F966**  
**4 FB966**  
 Mounting plate for gluing shower baskets and single hooks #3455  
 Monteringsplatta för limning av duschskorgar och enkelkrokar #3455  
 Monteringsbeslag til limning af brusekurve og enkel kroge #3455  
 Monteringsbelsag til liming av dusjkurver og enkel kroker #3455  
 Asennuslevy liimattaessa nuppikoukkuja #3455 ja osaa suihkukoreista Smedbon valikoimasta  
 Adapter zum Kleben Für Sideline, andere Körbe und #3455 aus dem Sortiment

**8 6000-13**  
 iCleaner Spray 30 ml + Cloth  
 iCleaner Spray 30 ml + duk  
 iCleaner Spray 30 ml + klud  
 iCleaner Spray 30 ml + klut  
 iCleaner Spray 30 ml + Mikrokuituliina  
 iCleaner Spray 30 ml + Tuch



EN **Drill-free mounting**

- Easy to mount
- Suitable for most Smedbo products\*
- Great strength
- Quick curing, 4 hours
- Easy to remove without damaging the surface

The mounting plate #966 should be used for gluing shower baskets and single hooks #3455.

\* Due to risk of high loads, we do not recommend gluing grab bars or swing arm towel rails. Nor should products from AIR and DRY series be glued.

SE **Montera utan att borra**

- Lätt att montera
- Passar de flesta Smedbo-produkter\*
- Fantastisk hållfasthet
- Snabbhärdande, 4 timmar
- Enkelt att ta bort utan överkan på underlaget

Duschkorgar och enkelkrokar limmas med monteringsplattan #966

\* På grund av risk för hög belastning rekommenderar vi ej limning av badkarshandtag och svängbara handduksstänger. Produkter ur serierna AIR och DRY bör heller inte limmas.

DK **Montere uden at borre**

- Let at montere
- Passer til alle SMEDBO produkter \*
- Stor holdbarhed
- Hurtig, hælder efter 4 timer
- Let at fjerne uden at beskadige underlaget

For brusekurve og enkle kroge #3455 købes separat monteringsplade, varenr #966.

\*Smedbo anbefaler ikke limning af badekarsgreb eller svingbar håndklædeholder. Eller produkter fra serien AIR og DRY.

NO **Montera uten å borre**

- Enkelt å montere med GlueMix lim
- Passer alle SMEDBO produkter \*
- Fantastisk heft
- Hurtig, herder etter 4 timer
- Enkel å fjerne uten å skade underlaget

Duschkorgar og enkelkrokar limmas med monteringsplattan #966

\* Smedbo anbefaler ikke å lime badekarshåndtak og svingbar håndklestang samt produkter i seriene AIR og DRY.

FI **Asenna ilman poraamista**

- Helppo asentaa
- Soveltuu useimmille Smedbo tuotteille
- Luja pitävyys
- Nopea kovettuminen, 4 tuntia
- Helppo poistaa vahingoittamatta alustaa

Suihkukorit ja nuppikoukut liimataan käyttäen asennuslevyä #966

\* Suurien kuormien vaaran vuoksi emme suosittele liimaamaan tukikahvoja ja kääntyviä pyyhketankoja. AIR ja DRY sarjojen tuotteita ei tule myöskään liimata.

DE **Einfach mit Kleberkleber zu installieren**

- Passt auf alle SMEDBO Produkte \*
- Große Stärke
- Heilt schnell nach 4 Stunden
- Einfach zu entfernen ohne auf das Substrat zu drücken

Für Duschkörbe und Einzelhaken separat erhältliche Montageplatte, Artikelnummer #966.

\* Smedbo empfiehlt nicht abzukleben Badgriffe oder schwenkbarer Handtuchhalter. Auch Produkte der Serien AIR und DRY gehören nicht dazu.







Products with a core of brass.  
 Produkter med kärna av mässing.  
 Produkter med en kerne af messing.  
 Produkter med en kjerne av messing.  
 Tuotteet, joiden ydin messinkiä.  
 Produkte mit einem Kern aus Messing.

	POLISHED CHROME	BRUSHED CHROME	POLISHED BRASS	BRUSHED BRASS	BLACK	WHITE
AIR	●					
HOME	●	●		●	●	
HOUSE	●	●	●		●	●
ICE	●					
POOL	●					
VILLA	●		●			
SIDELINE	●	●	●	●	●	●
OUTLINE	●				●	●



Products with a core of stainless steel.  
 Produkter med kärna av rostfritt stål.  
 Produkter med rustfritt stål kerne.  
 Produkter med en kjerne av rustfritt stål.  
 Tuotteet, joiden ydin ruostumatonta terästä.  
 Produkte mit einem Kern aus rostfreien Stahl.

	POLISHED STAIN-LESS STEEL	BRUSHED STAIN-LESS STEEL	CHROMED STAIN-LESS STEEL	BLACK	WHITE
DRY	●			●	●
OUTLINE	●	●			
OUTLINE LITE	●			●	●
LIVING	●		●		
SIDELINE	●		●	●	



10 Year warranty  
 5 Year warranty (DRY and Pedal Bins only)

10 års garanti  
 5 års garanti (DRY och Pedalhinkar)

10 års garanti  
 5 års garanti (DRY och Pedalhinkar)

10 års garanti  
 5 års garanti (DRY og pedalbøtter)



10 Vuoden takuu  
 5 Vuoden takuu (DRY ja poljinastiat)

10 Jahre Garantie  
 5 Jahre Garantie (DRY und Abfall - und Kosmetik Eimer)



SVERIGE  
SMEDBO AB  
BOX 13063  
S-250 13 HELSINGBORG  
SWEDEN  
TEL: +46 42 25 15 00  
E-MAIL: [info@smedbo.se](mailto:info@smedbo.se)  
[www.smedbo.se](http://www.smedbo.se)

DANMARK  
SMEDBO  
TEL: 45 83 58 08  
E-MAIL: [info@smedbo.dk](mailto:info@smedbo.dk)

FINLAND  
SMEDBO  
PUH: 0207 129 570  
E-MAIL: [info@smedbo.fi](mailto:info@smedbo.fi)

NORGE  
SMEDBO NORGE A/S  
TEL: 69 36 18 20  
FAKS: 69 36 18 21  
E-MAIL: [info@smedbo.no](mailto:info@smedbo.no)

DEUTSCHLAND  
SMEDBO GMBH  
AN DER STRUSBEK 68  
D-22926 AHRENSBURG  
TEL: 04102-2208-0  
FAX: 04102-2208-22  
E-MAIL: [info@smedbo.de](mailto:info@smedbo.de)

THE NETHERLANDS  
SMEDBO GMBH  
STADIONSTRAAT 11 C10  
4815 NC BREDA  
TEL: 0031 614135785  
E-MAIL: [info@smedbo.co.nl](mailto:info@smedbo.co.nl)

UNITED KINGDOM  
SMEDBO LTD  
PHONE: 0114 276 0707  
E-MAIL: [uksales@smedbo.com](mailto:uksales@smedbo.com)

USA  
SMEDBO INC  
881 S. NORTHPOINT BLVD.  
WAUKEGAN, IL 60085  
PHONE: 847-615-0000  
E-MAIL: [customerservice@smedbo.com](mailto:customerservice@smedbo.com)

 **SMEDBO**  
Life in your bathroom